

# LG SMART INVERTER

## COMMERCIAL AIR CONDITIONERS



### LG Electronics

<http://www.lg.com/global/business>  
<http://partner.lge.com/global>  
<http://blog.lghvacstory.com/>

Copyright © 2019 LG Electronics. All rights reserved.

Distributed by





# CONTENTS



What is Inverter? ..... 04

Why LG Smart Inverter? ..... 05

Line up ..... 08

Core benefit of LG Smart Inverter Single Split ..... 12

- The Evolution of LG Technology
- LG Smart Technology
- Energy Saving
- Comfort
- Reliability
- Convenience

LG Smart Inverter Single Split ..... 26

- Ceiling Mounted Cassette
- Ceiling Concealed Duct
- Ceiling Suspended Unit
- Floor Standing Unit
- Single Package

Control Solution ..... 66



# WHAT IS INVERTER?

Traditional compressors normally cease operation once the set temperature has been reached, then start again when the room gets warmer. This results in inefficient energy usage that increases energy bills. LG's Smart Inverter Single Split air conditioners on the other hand, operate much more efficiently, slowly decreasing and increasing output depending on the temperature outside and inside. This ultimately improves energy efficiency, as the air conditioner is able to control operational capacity.

## The Advantages of Inverter Control

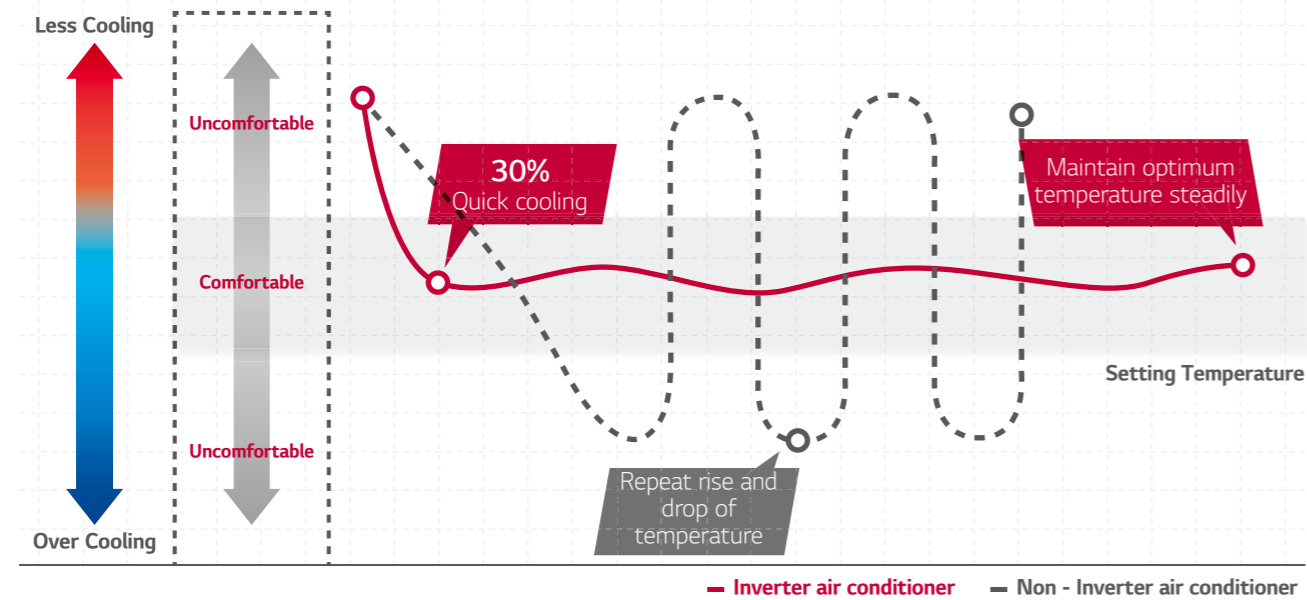

## Benefit of Inverter compressor

Inverter compressor maximizes energy efficiency, by adjusting energy supply as required.

### Constant Speed Compressor

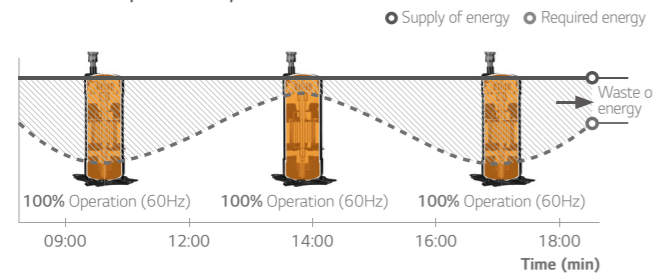

### Inverter Compressor

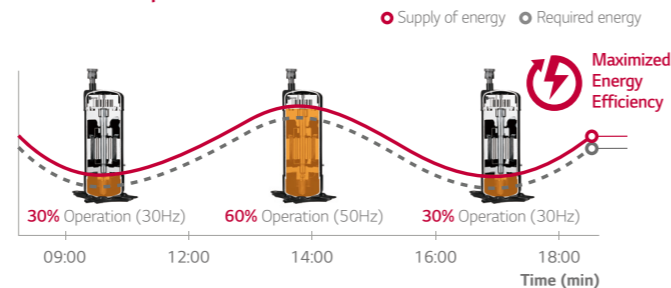

### Brain

Non inverter running at constant-speed has only two choices ; RUN or STOP. It runs at single speed without judging the ambient conditions. In contrast, Inverter operating at variable speed, can adjust its pace in the most efficient way.

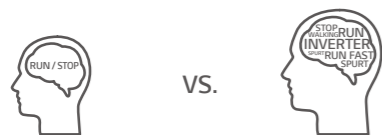

Constant Compressor

Inverter Compressor

### Dimmable lamp

Constant speed runs only On / Off operation, while variable speed adjusts its frequency upon external conditions, just like dimmable lighting can be controlled its brightness by ambient light.



Constant Compressor

Inverter Compressor

# WHY LG SMART INVERTER?

LG Inverter technology is applied to various electronics including refrigerators and washing machines which continuously receive global attention. Their best quality is the excellent level of technology provided by LG, a reputable electronic provider. LG is also known for its comprehensive HVAC provider while continuing innovation in technology. LG's latest Smart Inverter Single Split solutions are all equipped with the company's advanced Smart Inverter technology.

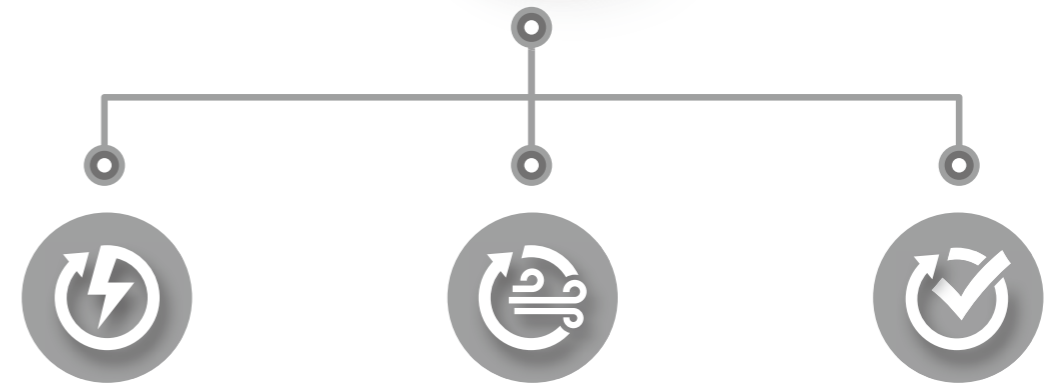
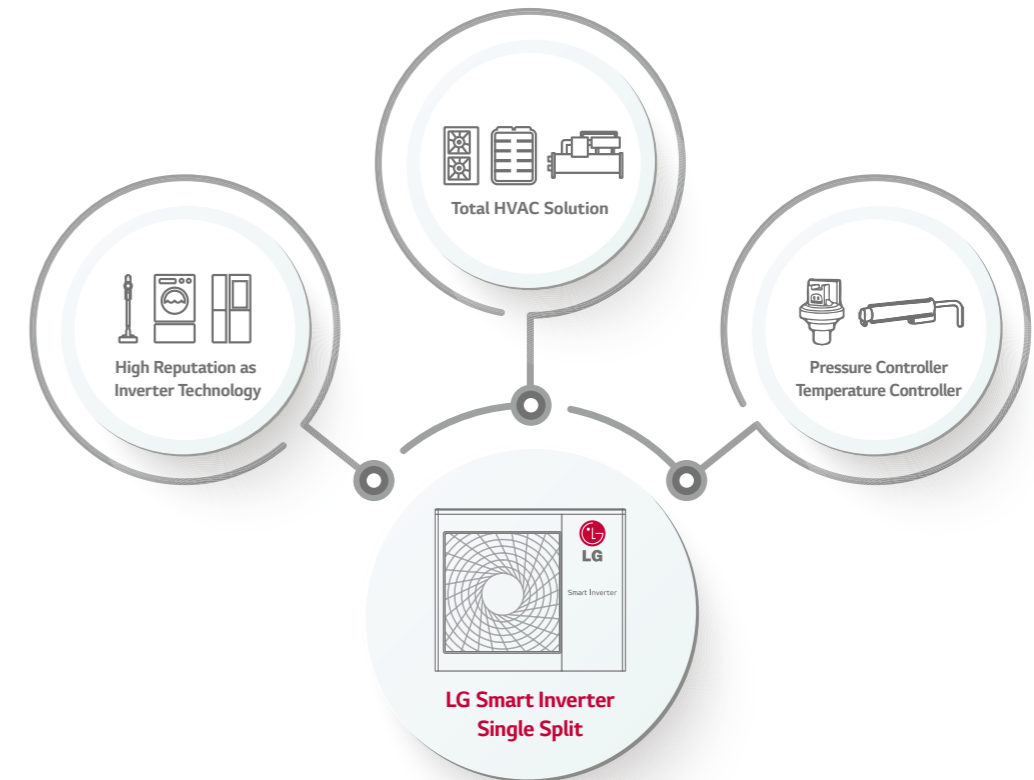

Energy Saving

More Efficient 40%

Comfort

30% Quick Cooling

Reliability

Wide Operation Range  
-10°C ~ 54°C

※ Specifications may vary for each model.



# HIGH / STANDARD SMART INVERTER SINGLE SPLIT







- Ceiling Mounted Cassette
- Ceiling Concealed Duct
- Ceiling Suspended Unit
- Floor Standing Unit
- Single Package











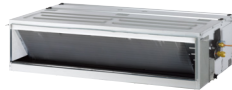









# SMART INVERTER SINGLE SPLIT - HIGH EFFICIENCY

## COOLING ONLY





CEILING CASSETTE						
						
<b>kBtu / kW</b>	<b>18 / 5.3</b>	<b>24 / 7.0</b>	<b>30 / 8.8</b>	<b>36 / 10.6</b>	<b>48 / 14.1</b>	<b>54 / 15.8</b>
Indoor Model Name	ATNQ18GPLT1	ATNQ24GPLT1	ATNQ30GPLT1	ATNQ36GNLT1	ATNQ48GMLT1	ATNQ54GMLT1
Outdoor Model Name	ATUQ18GPLT1	ATUQ24GPLT1	ATUQ30GPLT1	ATUQ36GNLT1	ATUQ48GMLT1	ATUQ54GMLT1

CEILING CONCEALED DUCT (MIDDLE STATIC)						
						
<b>kBtu / kW</b>	<b>18 / 5.3</b>	<b>24 / 7.0</b>	<b>30 / 8.8</b>	<b>36 / 10.6</b>	<b>48 / 14.1</b>	<b>54 / 15.8</b>
Indoor Model Name	ABNQ18GM1T1	ABNQ24GM1T1	ABNQ30GM1T1	ABNQ36GM3T1	ABNQ48GM3T1	ABNQ54GM3T1
Outdoor Model Name	ABUQ18GM1T1	ABUQ24GM1T1	ABUQ30GM1T1	ABUQ36GM3T1	ABUQ48GM3T1	ABUQ54GM3T1



CEILING SUSPENDED						
						
<b>kBtu / kW</b>	<b>18 / 5.3</b>	<b>24 / 7.0</b>	<b>30 / 8.8</b>	<b>36 / 10.6</b>	<b>48 / 14.1</b>	<b>54 / 15.8</b>
Indoor Model Name	AVNQ18GM1T1	AVNQ24GM1T1	AVNQ30GM1T1	AVNQ36GM2T1	AVNQ48GM2T1	AVNQ54GM2T1
Outdoor Model Name	AVUQ18GM1T1	AVUQ24GM1T1	AVUQ30GM1T1	AVUQ36GM2T1	AVUQ48GM2T1	AVUQ54GM2T1





SINGLE PACKAGE				
Capacity (RT)	3, 4, 5 RT	6.5, 7.5 RT	10, 12.5 RT	15, 17.5, 20, 25 RT
Single Package				
Model Name	AK-Q036GH50 AK-Q048GH50 AK-Q060GH50	AK-Q0788C01 AK-Q0908C01	AK-Q1208C01 AK-Q1508C01	AK-Q1808C01 AK-Q2108C01 AK-Q2408C01 AK-Q3008C01

## HEAT PUMP

CEILING CASSETTE						
						
<b>kBtu / kW</b>	<b>18 / 5.3</b>	<b>24 / 7.0</b>	<b>30 / 8.8</b>	<b>36 / 10.6</b>	<b>48 / 14.1</b>	<b>54 / 15.8</b>
Indoor Model Name	ATNW18GPLT1	ATNW24GPLT1	ATNW30GPLT1	ATNW36GNLT1	ATNW48GMLT1	ATNW54GMLT1
Outdoor Model Name	ATUW18GPLT1	ATUW24GPLT1	ATUW30GPLT1	ATUW36GNLT1	ATUW48GMLT1	ATUW54GMLT1

CEILING CONCEALED DUCT (MIDDLE STATIC)						
						
<b>kBtu / kW</b>	<b>18 / 5.3</b>	<b>24 / 7.0</b>	<b>30 / 8.8</b>	<b>36 / 10.6</b>	<b>48 / 14.1</b>	<b>54 / 15.8</b>
Indoor Model Name	ABNW18GM1T1	ABNW24GM1T1	ABNW30GM1T1	ABNW36GM3T1	ABNW48GM3T1	ABNW54GM3T1
Outdoor Model Name	ABUW18GM1T1	ABUW24GM1T1	ABUW30GM1T1	ABUW36GM3T1	ABUW48GM3T1	ABUW54GM3T1







CEILING SUSPENDED						
						
<b>kBtu / kW</b>	<b>18 / 5.3</b>	<b>24 / 7.0</b>	<b>30 / 8.8</b>	<b>36 / 10.6</b>	<b>48 / 14.1</b>	<b>54 / 15.8</b>
Indoor Model Name	AVNW18GM1T1	AVNW24GM1T1	AVNW30GM1T1	AVNW36GM2T1	AVNW48GM2T1	AVNW54GM2T1
Outdoor Model Name	AVUW18GM1T1	AVUW24GM1T1	AVUW30GM1T1	AVUW36GM2T1	AVUW48GM2T1	AVUW54GM2T1







FLOOR STANDING						
						
<b>kBtu / kW</b>				<b>36 / 10.6</b>	<b>48 / 14.1</b>	<b>96 / 28.2</b>
Indoor Model Name				APNW36GT3S1	APNQ50LT3E0* /APNW50GT3E0 /APNW50LT3E0	APNW100LFT0
Outdoor Model Name				APUW36GT3S1	APUQ50LT3E0* /APUW50GT3E0 /APUW50LT3E0	APUW100LFT0



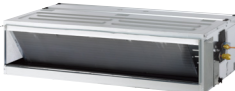

# SMART INVERTER SINGLE SPLIT - STANDARD



## HEAT PUMP (1Phase, 220 - 240V / 50Hz)



CEILING CASSETTE						
						
kBtu / kW	18 / 5.3	24 / 7.0	30 / 8.8	36 / 10.6	48 / 14.1	54 / 15.8
Indoor Model Name	ATNW18GPLS1	ATNW24GPLS1	ATNW30GPLS1	ATNW36GMLS1	ATNW48GMLS1	ATNW54GMLS1
Outdoor Model Name	ATUW18GPLS1	ATUW24GPLS1	ATUW30GPLS1	ATUW36GMLS1	ATUW48GMLS1	ATUW54GMLS1



CEILING CONCEALED DUCT (MIDDLE STATIC)						
						
kBtu / kW	18 / 5.3	24 / 7.0	30 / 8.8	36 / 10.6	48 / 14.1	54 / 15.8
Indoor Model Name	ABNW18GM1S1	ABNW24GM1S1	ABNW30GM1S1	ABNW36GM2S1	ABNW48GM3S1	ABNW54GM3S1
Outdoor Model Name	ABUW18GM1S1	ABUW24GM1S1	ABUW30GM1S1	ABUW36GM2S1	ABUW48GM3S1	ABUW54GM3S1

FLOOR STANDING						
						
kBtu / kW				36 / 10.6	48 / 14.1	
Indoor Model Name				APNW36GT3S1	APNW48GT3S1	
Outdoor Model Name				APUW36GT3S1	APUW48GT3S1	

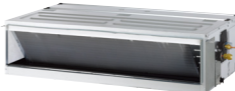
## HEAT PUMP (3Phase, 380 - 410V / 50Hz)

CEILING CASSETTE						
						
kBtu / kW					48 / 14.1	54 / 15.8
Indoor Model Name					ATNW48LMLS2	ATNW54LMLS2
Outdoor Model Name					ATUW48LMLS2	ATUW54LMLS2

CEILING CONCEALED DUCT (MIDDLE STATIC)						
						
kBtu / kW					50 / 14.7	60 / 17.6
Indoor Model Name					ABNW50LM3S1	ABNW60LM3S1
Outdoor Model Name					ABUW50LM3S1	ABUW60LM3S1

FLOOR STANDING						
						
kBtu / kW					48 / 14.1	
Indoor Model Name					APNW48LT3S1	
Outdoor Model Name					APUW48LT3S1	



# THE EVOLUTION OF LG TECHNOLOGY

## REVOLUTIONARY SCROLL COMPRESSOR

R1 Compressor



\* LG Internal test result, Based on single split 10 kW Cassette  
\*\* LG Internal test result, Based on conventional compressor (Rotary type GPT442M)

## INVERTER COMPRESSOR

High-efficiency inverter compressor developed for generations.

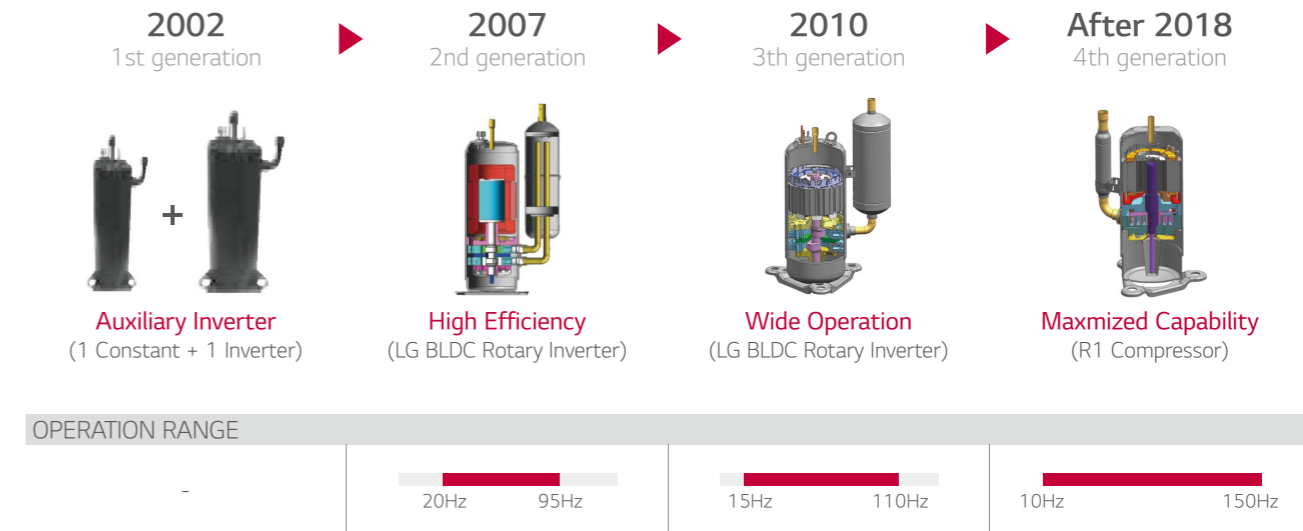

## REVOLUTIONARY SCROLL COMPRESSOR

Revolutionary Scroll Compressor is applied for high-efficiency and reliability. This type of compressor is more advanced compared to the conventional one. especially tilting motion of scroll has been improved. Further, the operation range is improved compared to the conventional type.

- Scroll compressor with simple structure
- Low noise (high speed possible)
- 20% weight reduction (vs. conventional compressor)
- High efficiency (low load at low speed / total efficiency)
- Improved Tilting Motion of scroll

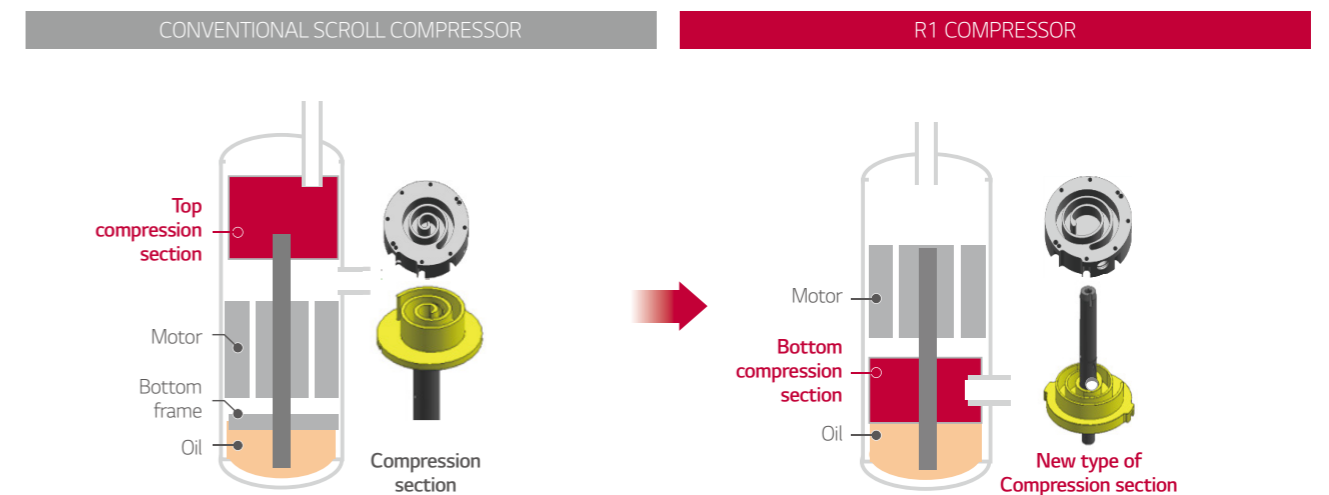

※ Refer to each model PDB for applicable models.



# LG SMART TECHNOLOGY

## POWER COOLING AT THE LONG PIPE

It has capacity of 10% higher more than constant model at the 50m pipe length.

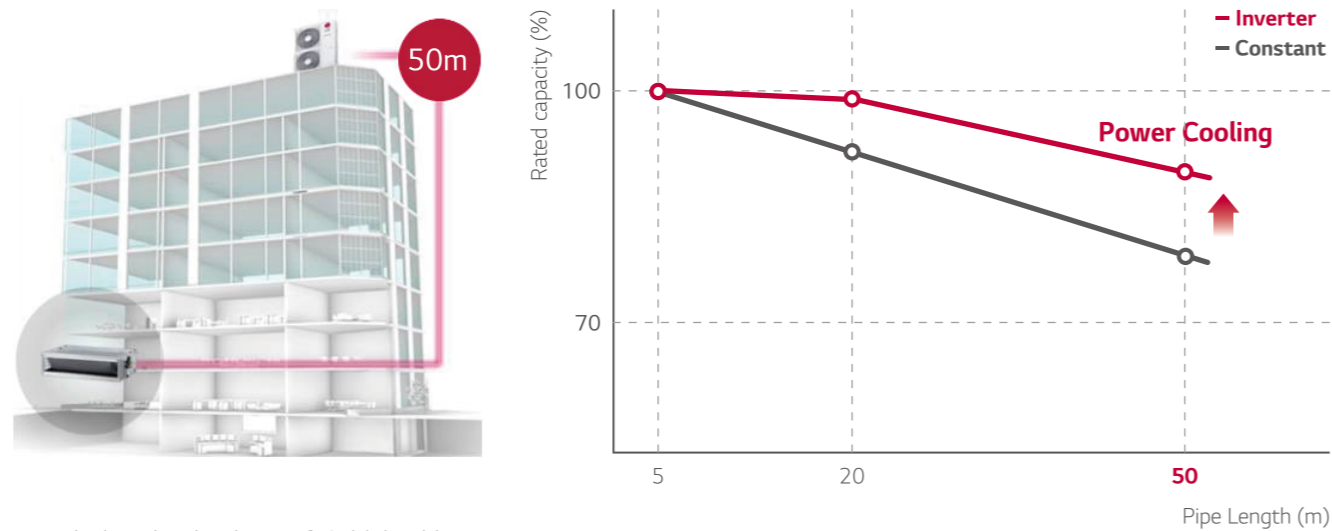

※ The data is based on the PDB of LG global model.  
 ※ Test condition (Temperature) : 27 / 35 °C (Indoor / Outdoor)

## COMFORT COOLING WITH HUMIDITY SENSOR

'Comfort Cooling' is a function that changes evaporation temperature according to temperature & humidity.

Conventional model



Temperature sensor

LG Single Split



Temperature sensor



Humidity sensor

Comfortable and power saving control based on indoor humidity\*\*



Display Humidity



Display Temperature

Wired Remote Controller  
 Standard III  
 (Accessory)

**Max. 18% Energy Saving\***

\* Test condition :  
 - Indoor Temp. 27 °C (DB) / 26.4°C (WB)  
 - Outdoor Temp. 35 °C (DB) / 24°C (WB)  
 - Applied model : AT-\*1 8GPLT1



\*\* To apply humidity sensor, new remote controller, PREMTB100 or PREMTBB10 is needed

## COMFORT COOLING WITH HUMIDITY SENSOR

'Comfort Cooling' is a function that changes evaporation temperature according to temperature & humidity.

Dual Sensing Control - Dry Summer

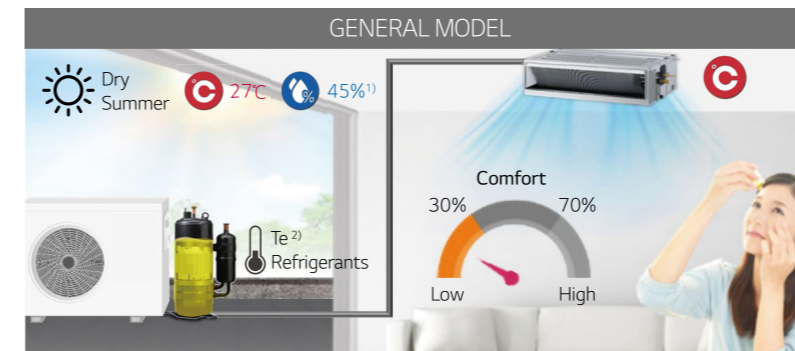

**Uncomfortable Environment**  
 Excessive latent heat elimination regardless of humidity

**Waste Energy**  
 Eliminate latent heat unnecessarily

LG SINGLE SPLIT

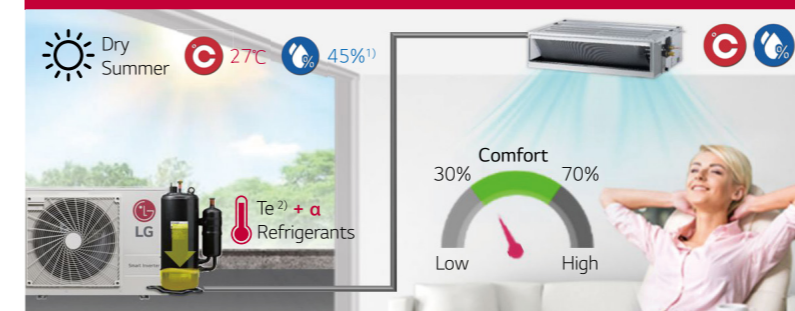

**Comfortable Environment**

By making the room less dry  
**Increased Energy Efficiency**  
 Provide optimized cooling and save energy considering humidity  
 - Humidity Condition : Low (< 30%), Standard (30~70%)

1) Indoor Condition  
 2) Evaporation Temperature

Dual Sensing Control - Wet Summer

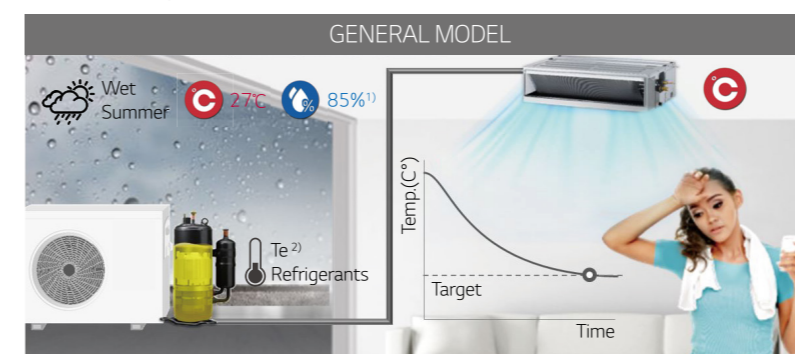

**Uncomfortable Environment**  
 General latent heat elimination regardless of humidity

LG SINGLE SPLIT

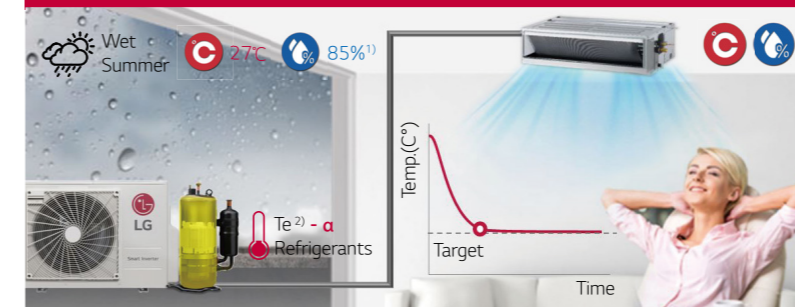

**Comfortable Environment**  
 With quick latent heat elimination by sensing humidity

1) Indoor Condition  
 2) Evaporation Temperature



# ENERGY SAVING

## BENEFIT OF PARTIAL LOAD PERFORMANCE

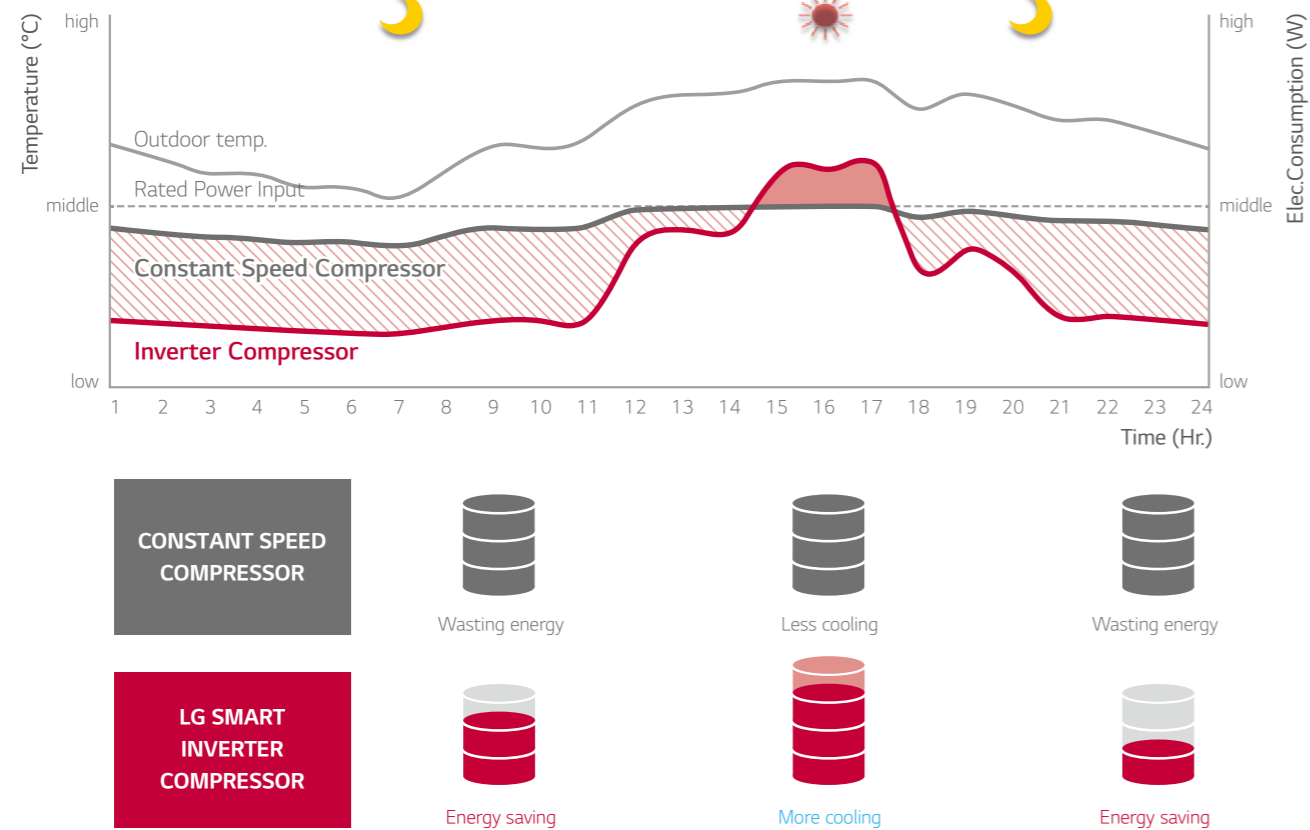

## ENHANCED HEAT EXCHANGE BY WIDE LOUVER PLUS FIN

Wide Louver Plus fin technology increases 11% of full load heating performance and 6% of COP compared to conventional fin. It can slow down frosting of heat exchanger and postpone the start of defrosting operation.

### Heating Operation at Defrost Condition

It can slow down frosting of heat exchanger and postpone the start of defrosting operation.

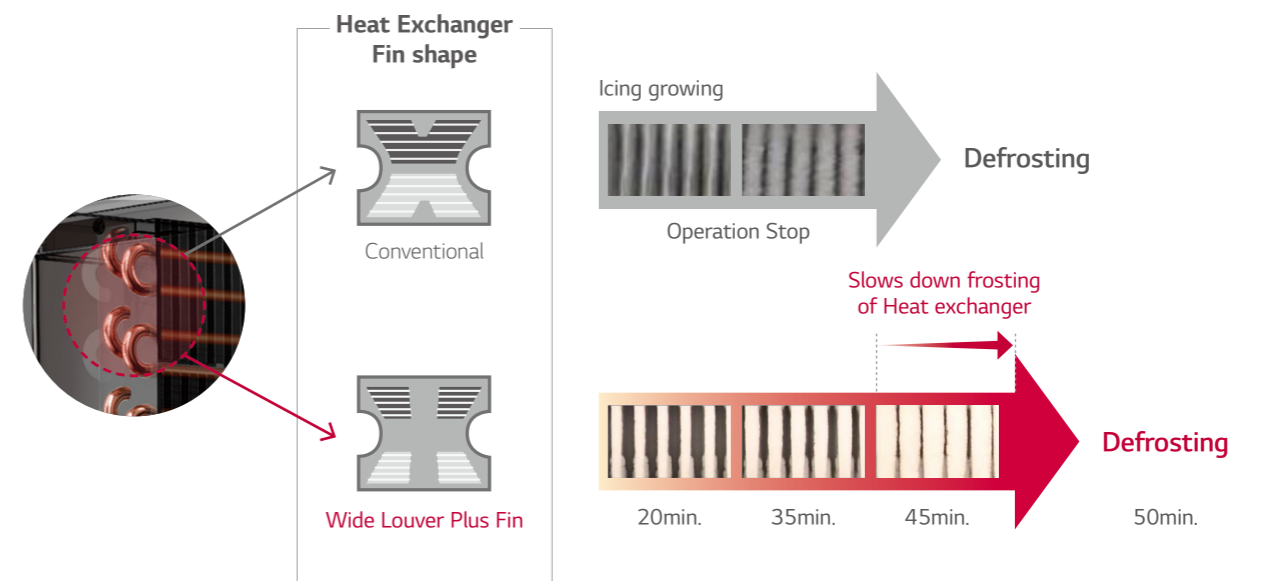

## POWERFUL BLDC (BRUSHLESS DIRECT CURRENT MOTOR) COMPRESSOR

LG air conditioners are equipped with a BLDC Inverter Twin Rotary Compressor that uses a neodymium magnetic core. The compressor has high efficiency and superior reliability, because it is excellent in controlling the operating speed depending on the load. The compressor has improved efficiency compared to standard AC inverter products and optimized for changes of outdoor load. Especially it is optimized for seasonal efficiency.

### Operation Range

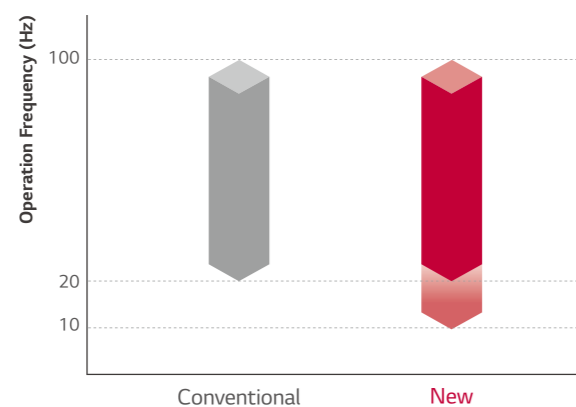

### Motor Efficiency

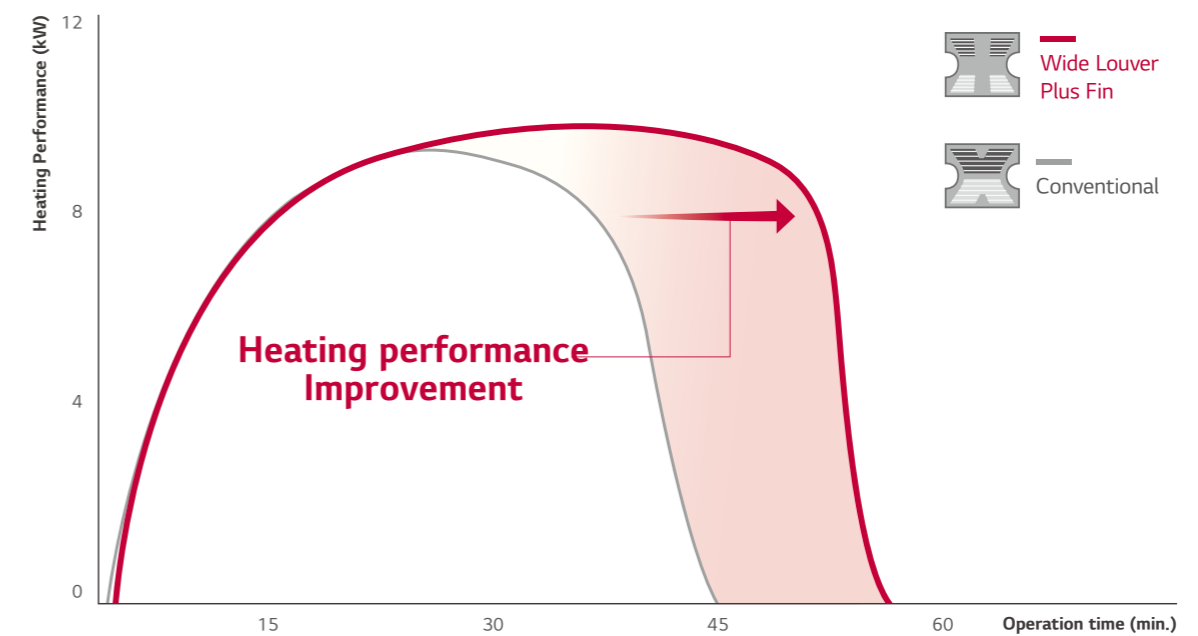
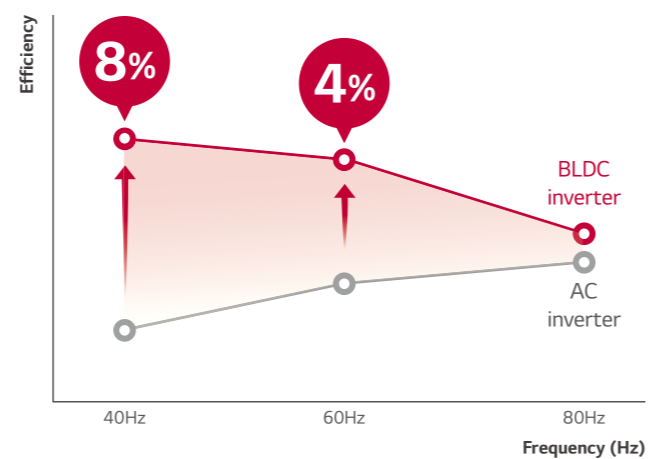

※ LG Internal test data



# COMFORT

## QUICK COOLING

At the same condition, the inverter reaches the set temperature about 30% faster than the constant speed.

SMART SENSORS



Temperature Sensor

+



Pressure Sensor

Sensing and ready for operation

Quick and reliable operation



30%

QUICK COOLING

\* 30% faster than the constant speed

## LOW NOISE

Inverter makes lower noise than constant speed due to adjustable frequency according to the load.

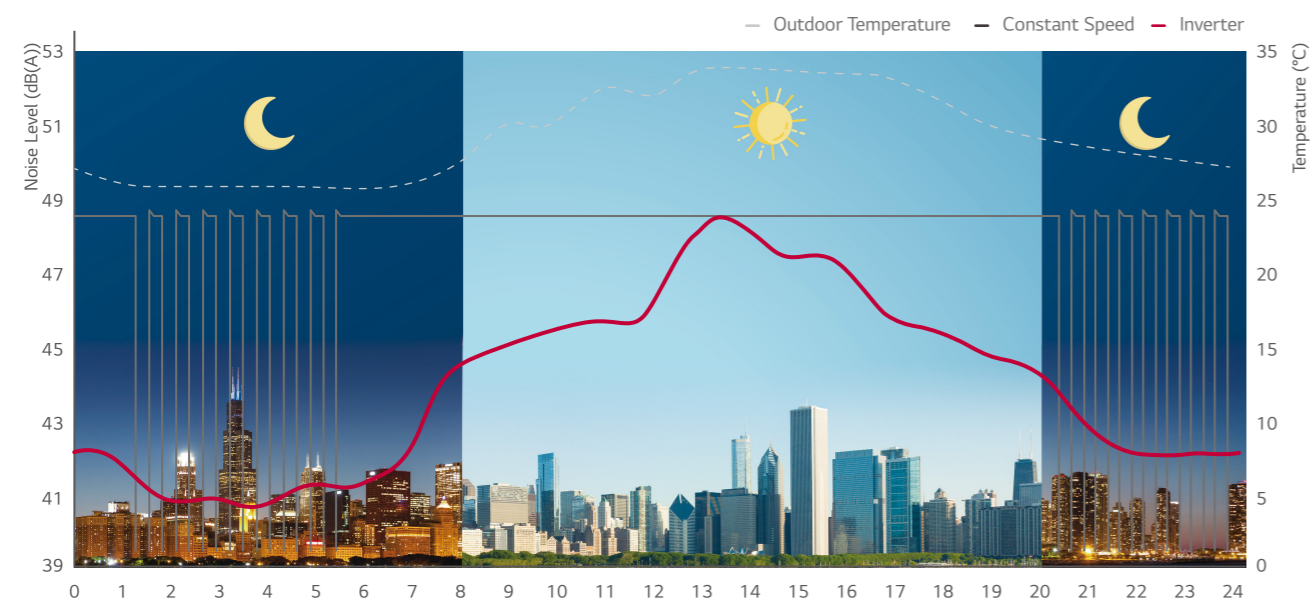

※ Noise level in residential environment : 60dB(A) : Normal conversation, 50dB(A) : office, 40dB(A) : Livingroom  
 ※ This result can be different depending on actual environment.  
 ※ The value of noise level is based on "A\*UW18G\*\*T2"

## OPTIMUM COOLING

When indoor temperature reaches near to the target temperature, LG Smart Inverter adjusts its discharge air temperature to prevent the indoor from being overcooled.

CONSTANT SPEED COMPRESSOR

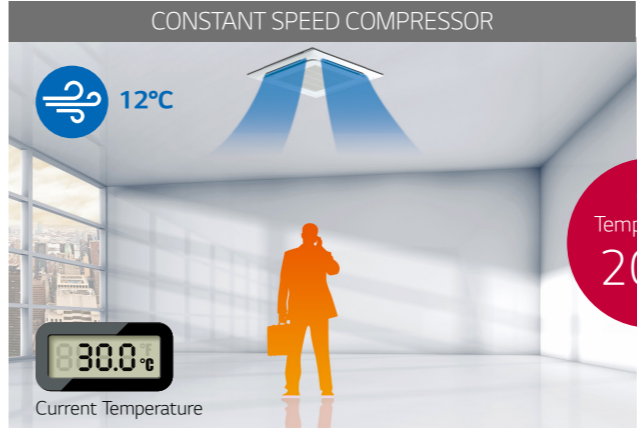

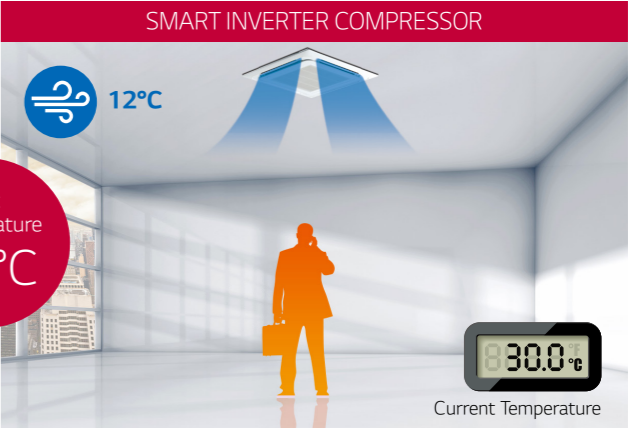

SMART INVERTER COMPRESSOR













# RELIABILITY

## INVERTER CONTROL

Smart sensors make quick and precise cooling possible. (Same sensor with Multi V)

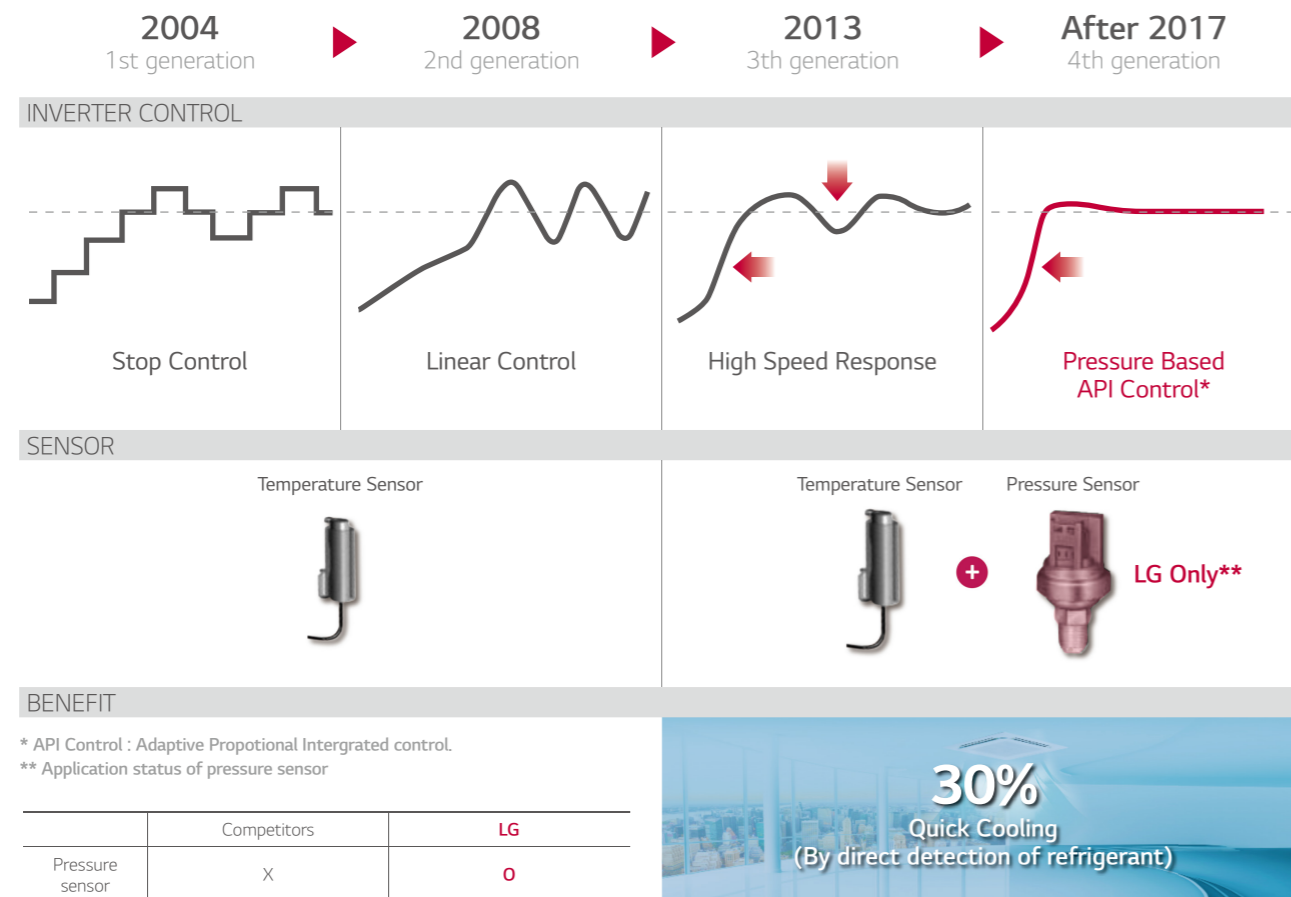

## QUICK OPERATING RESPONSE

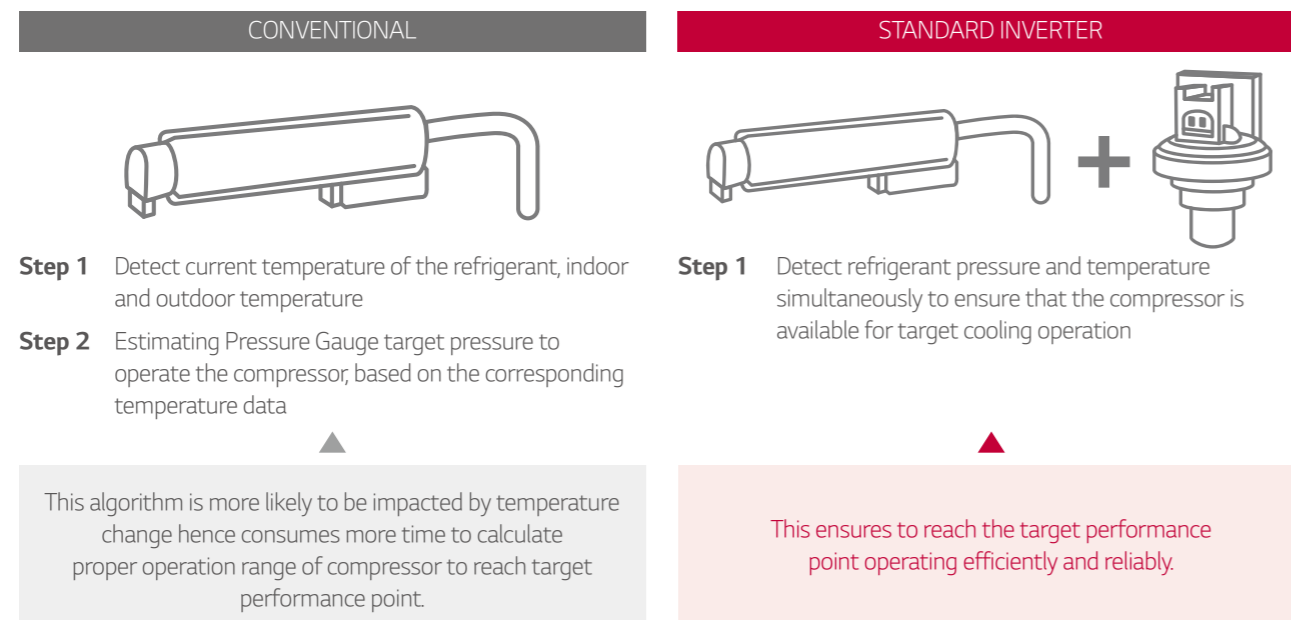

## WIDE OPERATION RANGE

At the same condition, the inverter reaches the set temperature about 30% faster than the constant speed.



※ Different from the model : The operation range of some model is from 0°C to 54°C.

## HIGH AND LOW VOLTAGE PROTECTION

Below low voltage limit, inverter compressor reduces frequency(Hz) and boost DC voltage, over high voltage limit, cuts off the relay to prevent damage of DC capacitor.

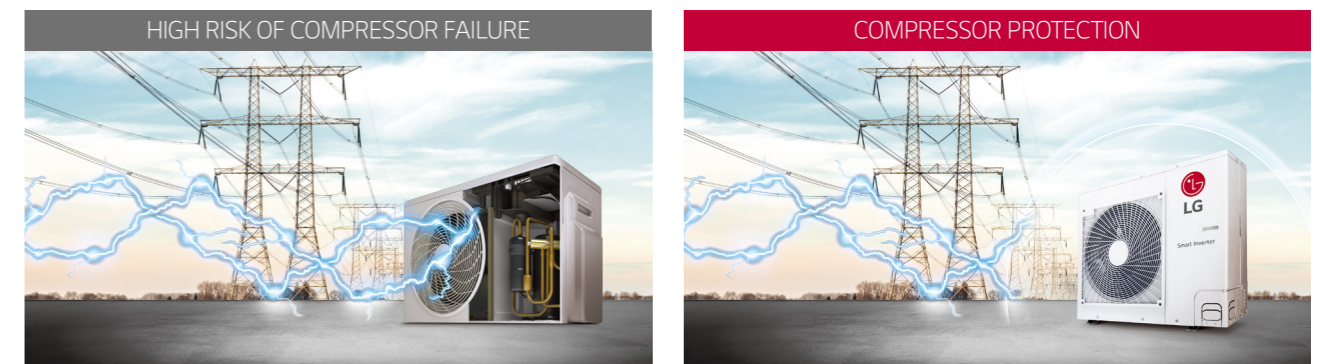

## CORROSION RESISTANT HEAT EXCHANGER

The gold-colored special coating on the fin of the heat exchanger prevents corrosion, extending the life of the unit.

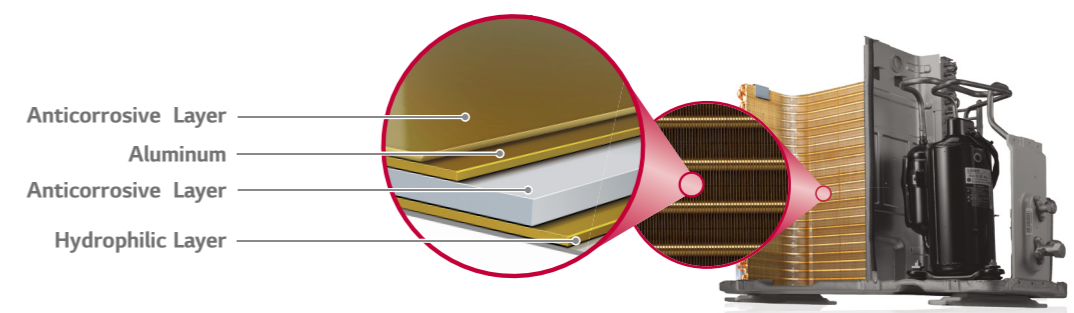

# CONVENIENCE

## SMART ThinQ

Control your air conditioners via using the smart internet devices as Android or iOS based smartphones.



### Simple operation for various functions

- On / Off
- Mode Selection
- Current temperature
- Set temperature
- Vane Control
- Reservation
- Energy Monitoring
- Filter Management

※ Search "LG Smart ThinQ" on Google market or Appstore then download the app.  
 ※ Wi-Fi modem (PWFMD200) is required by option.

## SIMs MODULE

Monitor the status of your air conditioner and diagnose problems by connecting it to a smartphone via a SIMs Module.



### Easy Monitoring

Diagnose problems anytime, anywhere with a SIMs Module.

### Easy Diagnosis & Quick Response

Easily monitor IDU / ODU and diagnose problems. Save and review diagnostic data.

**Main**

- Current outdoor temperature
- Indoor temperature
- Inverter comp frequency
- Operating opening
- Error code / Frequency limits Indoor
- Outdoor fan speed

**Indoor Unit**

- Indoor Unit Capacity / Operation Mode
- THM mode / REM mode
- FAN operating condition / EEV opening
- Room Temperature / Suction Temperature
- Intermediate Temperature
- Exit Temperature

**Outdoor Unit**

- Frequency / Fan RPM
- DC Link / Input Current
- Input Voltage
- EEV operation mode
- Restart timer
- Compressor mode / EEV opening

**Chart**

- Room Temperature
- Heat exchanger pipe temperature
- Compressor discharge temperature
- Frequency / Outdoor temperature
- Compressor suction temperature
- Electric current / Voltage

※ Search "LG SIMs" on Google market or Appstore then download the app.

## SIMPLE PUMP DOWN

Simple pump down provides easy maintenance and save the service time.

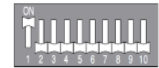
MANUAL PUMP DOWN		SIMPLE PUMP DOWN (LG INVERTER)	
<b>Time consuming and inconvenience</b> Conduct the pump down by setting at outdoor unit and indoor unit respectively		<b>Save time and simple maintenance</b> Start pump down simply by setting dip switch on PCB in outdoor unit	
<b>Imprecise pump down</b> Assuming ref. amount empirically		<b>Precise pump down (LED signal)</b> Measuring ref. amount by pressure sensor and alarm LED signal	
Action	Setting by	Action	Setting by
Cooling operation start by Indoor remote controller	IDU	Dip switch On 	ODU
Vapor pipe valve closed assuming ref. amount in person	ODU	Vapor Pipe valve closed after checking LED signal	ODU

※ Pump down : When an outdoor or indoor unit malfunctions, this function collects its refrigerant inside outdoor unit before servicing.

## WEEKLY PROGRAM

You can allot 2 reservations for one day, and up to 14 reservations for a week.

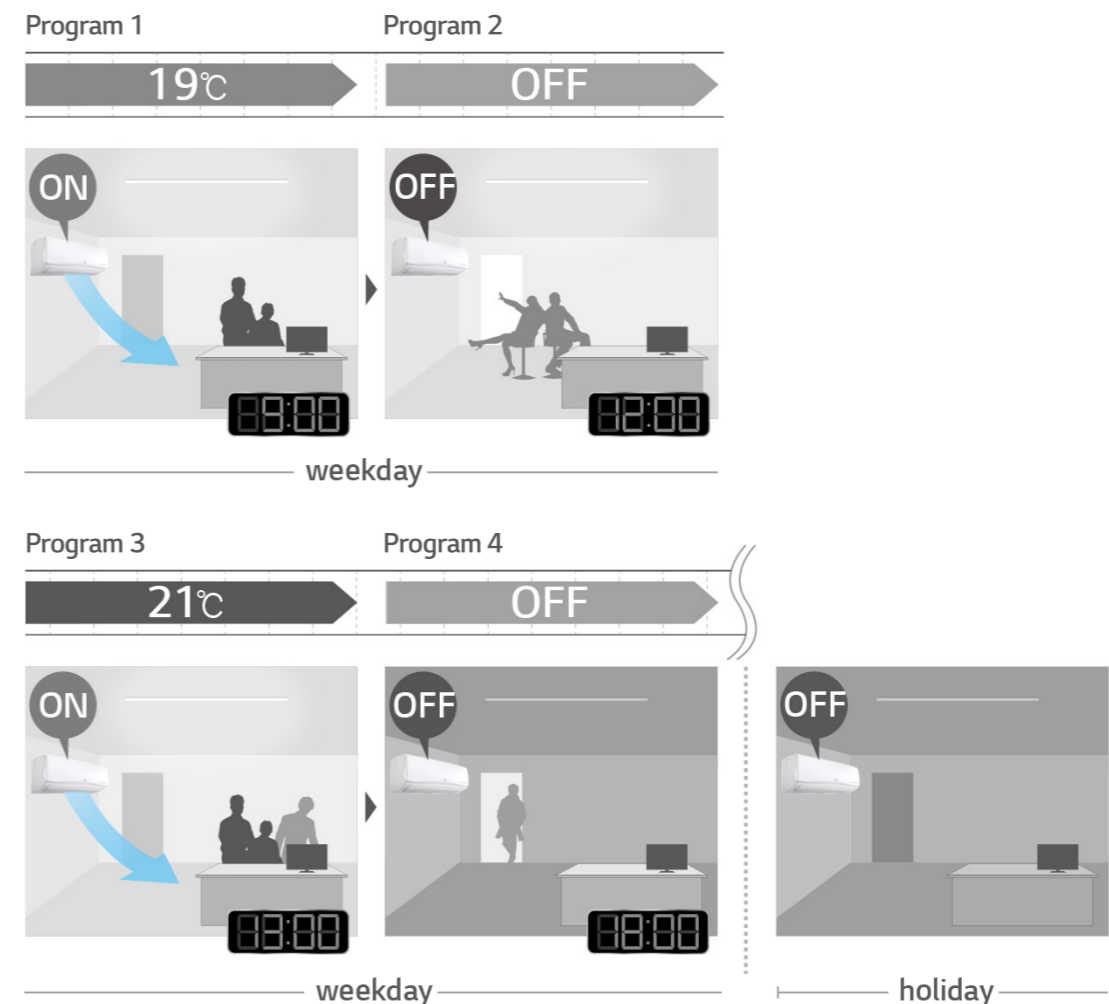



# CONVENIENCE

## FORCED COOLING OPERATION

This function allows the refrigerant to be recharged or pumped down, regardless of the indoor temperature.  
Note that this function can be used when indoor units are being moved or repaired.

### RECHARGING

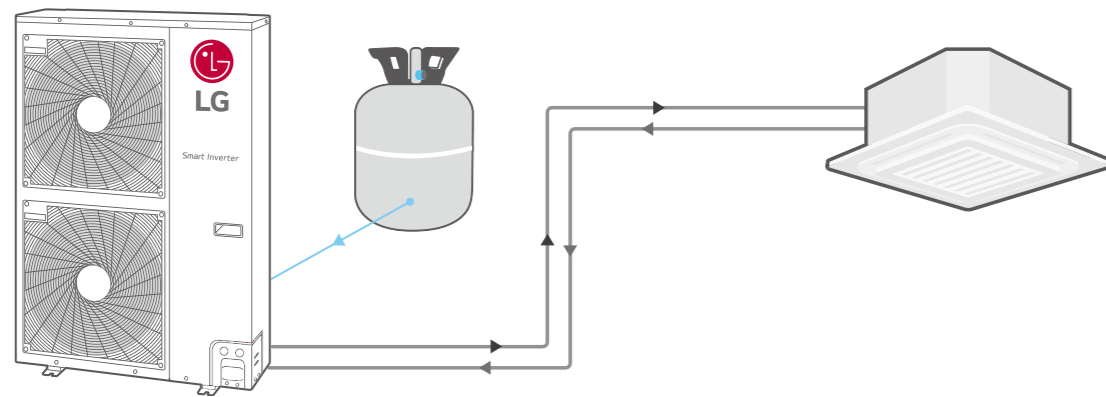

### PUMP DOWN

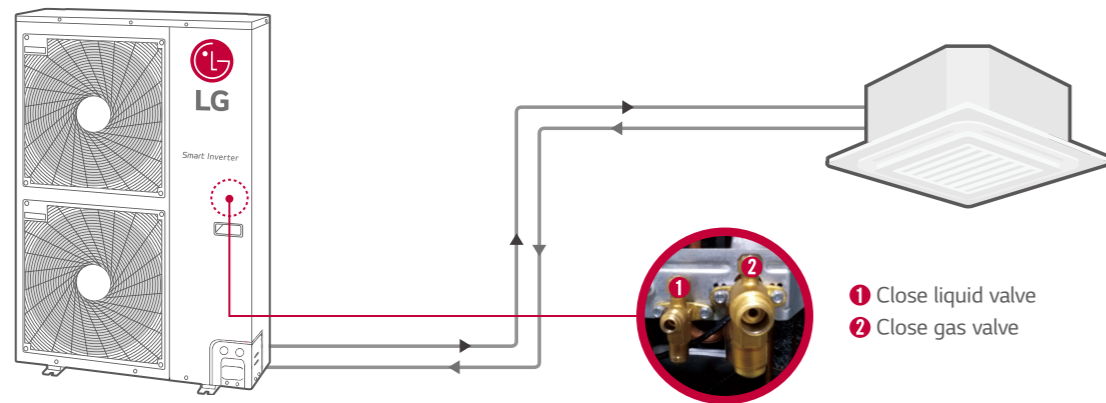

## HUMAN DETECTION SENSOR & HUMIDITY SENSOR



Human detection sensor (PTVSM0)

- Apply human detection sensor
- Apply vision sensor
- Saving energy
- Supply comfortable air flow
- The sensor is an optional accessory that can only be applied on PT-MCHW0



### Detection

Motion sensors detect the activity of people per 10seconds



### Detection range

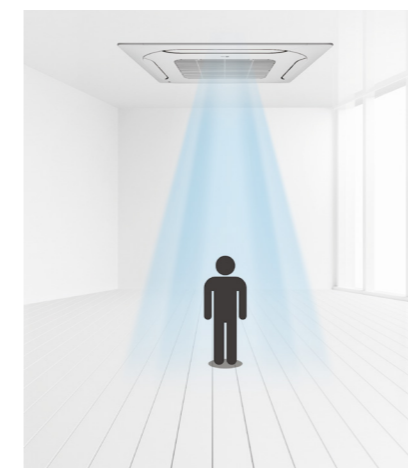

Height 3.2 (15 x 8m)



Height 3.5 (16 x 10m)



A sensor is installed 90° rotation  
12 x 6m → 6 x 12m detecting



# CEILING MOUNTED CASSETTE



## STYLISH DESIGN PANEL

New 4 way cassette panel adapted a unibody shape that matches with the ceiling.

### Interior fit



### Lineless surface



### Detachable corner

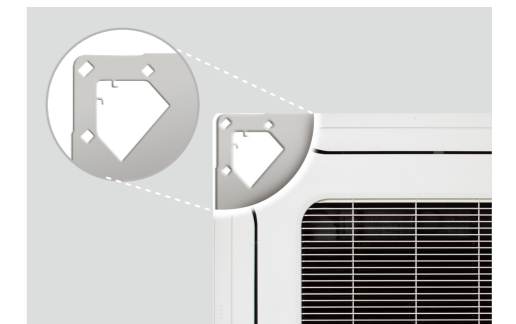

reddot design award

※ Old Panel : PT-UMC1 / New Panel : PT-MCHW0

## COMPACT SIZE

Slim & compact design not only saves space but also reduces installation costs. It's designed to suit most of building designs and fit into various spaces.



Length Width : 840 x 840mm

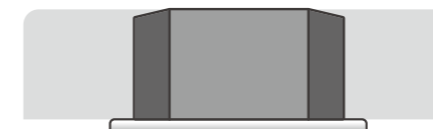

Conventional

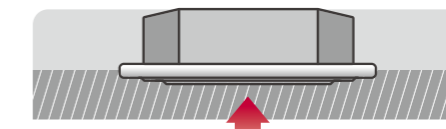

LG



# CEILING MOUNTED CASSETTE

## INDEPENDENT VANE OPERATION

The independent vane operation feature uses separate motors, making it possible to control all four vanes independently.

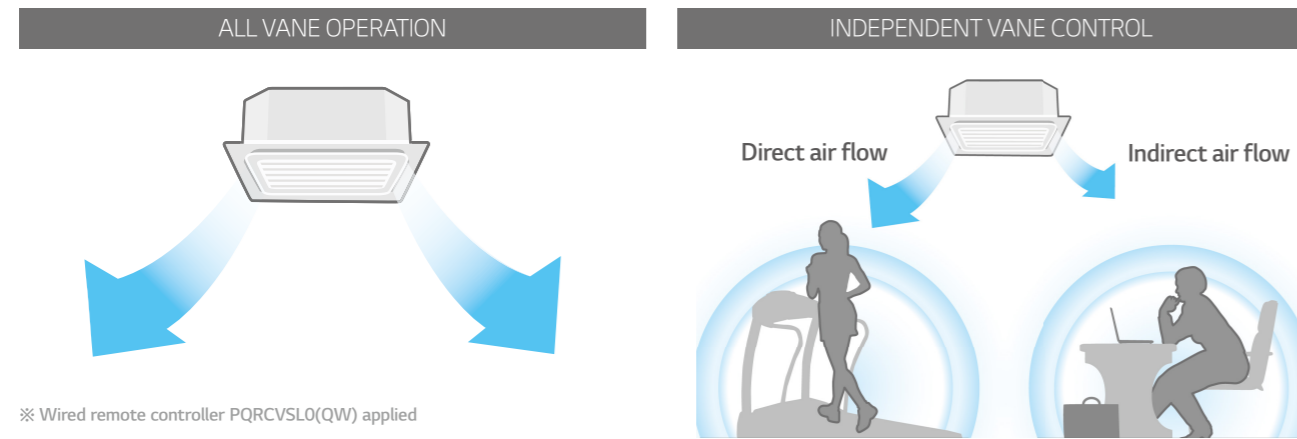

## PREVENT CEILING POLLUTION

Coanda design of air outlet can prevent contamination of ceiling.

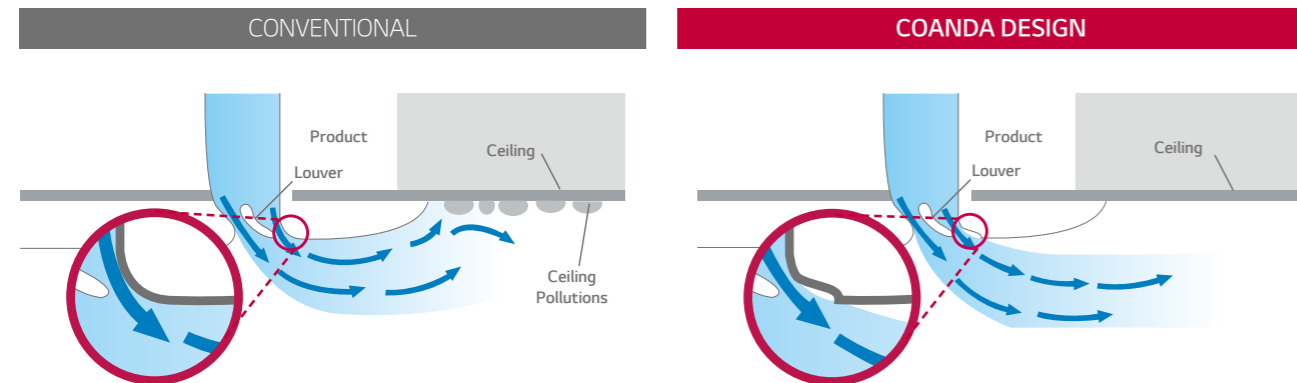

## HIGH CEILING MODE

Airflow in a space with a 4.2m ceiling height is possible with this indoor unit. Further, air flow can be strengthened by adjusting the fan speed.

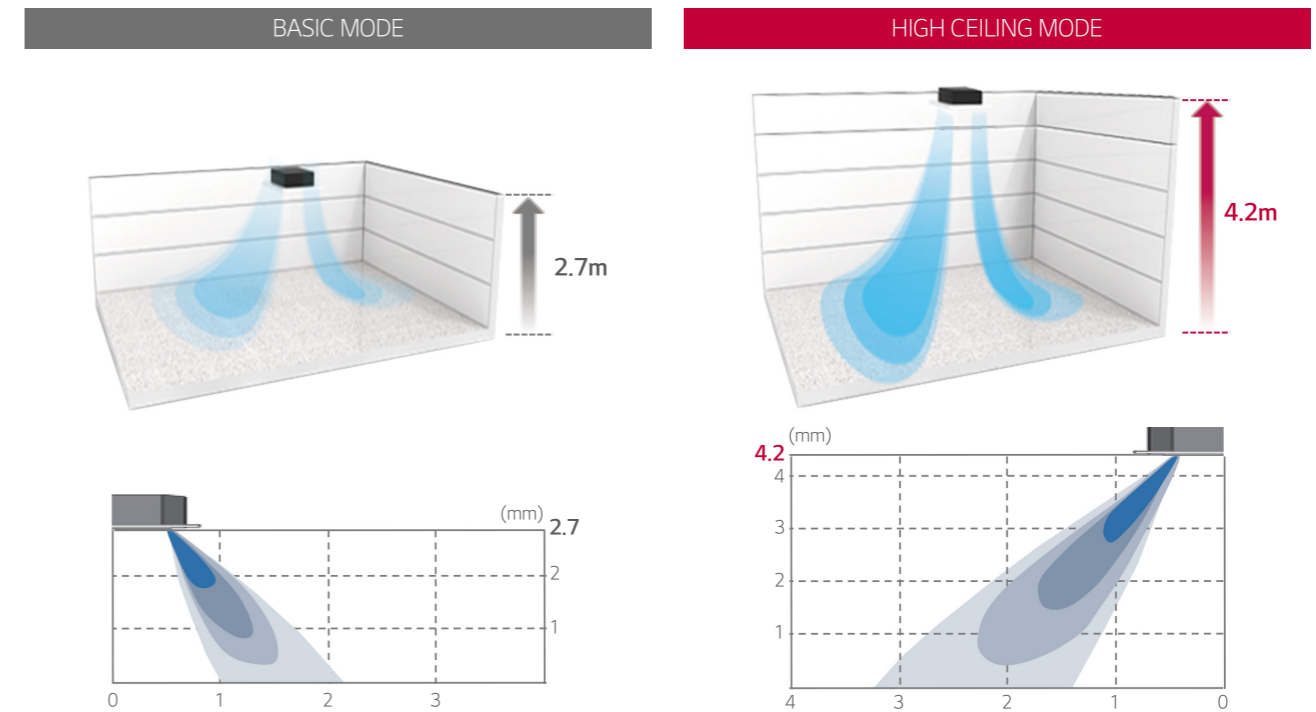

## CONVENIENT PANEL INSTALLATION

The detachable corner design makes it easy to adjust the hanger during installation and to check for leakages in the drain connection pipe. And it is easy to install the panel to the body, using the button type panel design.

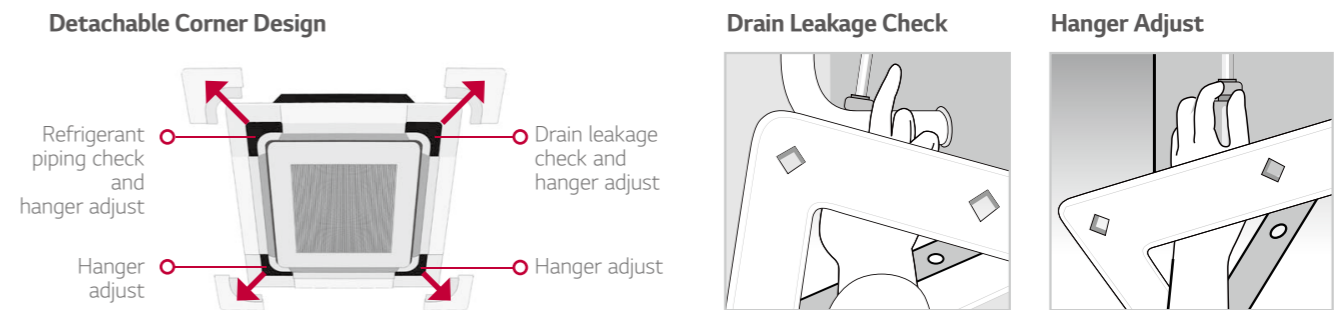

It is easy to install the panel to the body, using the button type panel design.

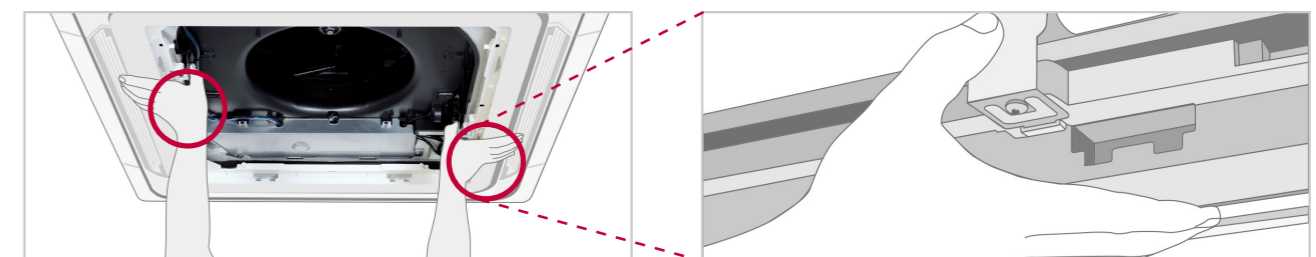

# SPECIFICATIONS

## CEILING MOUNTED CASSETTE - HIGH EFFICIENCY (INVERTER / 1 PHASE)

ATUQ18GPLT1 / ATUQ24GPLT1 / ATUQ30GPLT1 / ATUQ36GNLT1 / ATUQ48GMLT1 / ATUQ54GMLT1



### COOLING ONLY

Combination	Outdoor unit		Unit	ATUQ18GPLT1	ATUQ24GPLT1
	Indoor unit			ATNQ18GPLT1	ATNQ24GPLT1
Cooling Capacity <sup>1</sup>	Min. - Rated - Max.		kW	2.1-5.27-5.86	2.81-7.03-8.2
			Btu/h	7200-18000-20000	9600-24000-28000
Cooling Capacity <sup>2</sup>	Min. - Rated - Max.		kW	4.53	5.86
			Btu/h	15,450	20,000
Power Input	Cooling <sup>1</sup>	Rated	kW	1.55	2.06
	Cooling <sup>2</sup>	Rated	kW	1.71	2.25
EER / COP			W/W	3.4	3.41
<b>Outdoor</b>			<b>Unit</b>	<b>ATUQ18GPLT1</b>	<b>ATUQ24GPLT1</b>
Power Supply			V, ∅, Hz	220-240, 1, 50	220-240, 1, 50
Power Supply Cable (included Earth)			No. × mm <sup>2</sup>	3C × 2.5	3C × 2.5
Casing Color			-	Warm Gray	Warm Gray
Dimensions	Net	W × H × D	mm	770 × 545 × 288	870 × 650 × 330
Weight	Net		kg	34.3	43.3
Compressor	Type		-	Twin Rotary	Twin Rotary
Refrigerant	Type		-	R410A	R410A
Fan Motor	Type			BLDC	BLDC
Sound Pressure Level	Cooling	Rated	dB(A)	49	50
Piping Connections	Liquid	Outer Dia.	mm (inch)	∅ 6.35 (1/4)	∅ 9.52 (3/8)
	Gas	Outer Dia.	mm (inch)	∅ 12.7 (1/2)	∅ 15.88 (5/8)
Piping Length		Rated	m	5	5
		Max.	m	30	50
Maximum Height Difference (ODU - IDU)	Max.	m		15	30
<b>Indoor</b>			<b>Unit</b>	<b>ATNQ18GPLT1</b>	<b>ATNQ24GPLT1</b>
Panel Name				PT-UMC1 / PT-MCHWO *	PT-UMC1 / PT-MCHWO *
Power Supply			V, ∅, Hz	220-240, 1, 50	220-240, 1, 50
Dimensions	Net	W × H × D	mm	840 × 204 × 840	840 × 204 × 840
	Decoration Panel	W × H × D	mm	950 × 25 × 950	950 × 25 × 950
Weight	Net		kg	19.6	20.5
Air Flow Rate		H / M / L	m <sup>3</sup> /min	17.0 / 15.0 / 13.0	17.0 / 15.0 / 13.0
Fan Motor	Type			BLDC	BLDC
Safety Device				Fuse	Fuse
Sound Pressure Level		H / M / L	dB(A)	36 / 34 / 32	38 / 36 / 34

\* Old Panel : PT-UMC1 / New Panel : PT-MCHWO

#### Notes

- Cooling<sup>1</sup> : Indoor Temperature 27°C (80.6°F) DB / 19°C (66.2°F) WB, Outdoor Temperature 35°C (95°F) DB / 24°C (75.2°F) WB  
 - Cooling<sup>2</sup> : Indoor Temperature 29°C (84.2°F) DB / 19°C (66.2°F) WB, Outdoor Temperature 46°C (114.8°F) DB / 24°C (75.2°F) WB

### COOLING ONLY

ATUQ30GPLT1	ATUQ36GNLT1	ATUQ48GMLT1	ATUQ54GMLT1
ATNQ30GPLT1	ATNQ36GNLT1	ATNQ48GMLT1	ATNQ54GMLT1
3.44-8.2-9.38	4.7-9.99-11.13	5.392-13.48-15.53	6.328-15.82-16.7
11760-28000-32000	16030-34100-38000	18400-46000-53000	21600-54000-57000
7.38	8.49	11.45	12.34
25,200	28,980	39,100	42,120
2.41	2.93	3.96	5.39
3.02	3.44	4.66	5.40
3.4	3.41	3.4	2.94
ATUQ30GPLT1	ATUQ36GNLT1	ATUQ48GMLT1	ATUQ54GMLT1
220-240, 1, 50	220-240, 1, 50	220-240, 1, 50	220-240, 1, 50
3C × 2.5	3C × 2.5	3C × 6.0	3C × 6.0
Warm Gray	Warm Gray	Warm Gray	Warm Gray
950 × 834 × 330	950 × 834 × 330	950 × 1,380 × 330	950 × 1,380 × 330
59.1	59.1	89.5	89.5
Twin Rotary	Twin Rotary	LG Inverter Scroll	LG Inverter Scroll
R410A	R410A	R410A	R410A
BLDC	BLDC	BLDC	BLDC
51	51	55	55
∅ 9.52 (3/8)	∅ 9.52 (3/8)	∅ 9.52 (3/8)	∅ 9.52 (3/8)
∅ 15.88 (5/8)	∅ 15.88 (5/8)	∅ 19.05 (3/4)	∅ 19.05 (3/4)
5	5	5	5
50	50	75	75
30	30	30	30
ATNQ30GPLT1	ATNQ36GNLT1	ATNQ48GMLT1	ATNQ54GMLT1
PT-UMC1 / PT-MCHWO *	PT-UMC1 / PT-MCHWO *	PT-UMC1 / PT-MCHWO *	PT-UMC1 / PT-MCHWO *
220-240, 1, 50	220-240, 1, 50	220-240, 1, 50	220-240, 1, 50
840 × 204 × 840	840 × 246 × 840	840 × 288 × 840	840 × 288 × 840
950 × 25 × 950	950 × 25 × 950	950 × 25 × 950	950 × 25 × 950
20.5	23.3	25.5	25.5
19.0 / 17.0 / 15.0	23.0 / 21.0 / 19.0	32.0 / 30.0 / 28.0	32.0 / 30.0 / 28.0
BLDC	BLDC	BLDC	BLDC
Fuse	Fuse	Fuse	Fuse
41 / 38 / 36	42 / 40 / 38	44 / 42 / 40	44 / 42 / 40



# SPECIFICATIONS

## CEILING MOUNTED CASSETTE - HIGH EFFICIENCY (INVERTER / 1PHASE)

ATUW18GPLT1 / ATUW24GPLT1 / ATUW30GPLT1 / ATUW36GNLT1 / ATUW48GMLT1 / ATUW54GMLT1



### HEAT PUMP

Combination	Outdoor unit		Unit	ATUW18GPLT1	ATUW24GPLT1
	Indoor unit			ATNW18GPLT1	ATNW24GPLT1
Cooling Capacity <sup>1</sup>	Min. - Rated - Max.	kW	2.1-5.27-5.86	2.81-7.03-8.2	
		Btu/h	7200-18000-20000	9600-24000-28000	
Cooling Capacity <sup>2</sup>	Min. - Rated - Max.	kW	4.53	5.86	
		Btu/h	15450	20000	
Heating Capacity <sup>1</sup>	Min. - Rated - Max.	kW	2.1-5.27-6.1	2.8-7.03-8.2	
		Btu/h	7200-18000-21000	9600-24000-28000	
Power Input	Cooling <sup>1</sup>	Rated	kW	1.55	2.06
	Cooling <sup>2</sup>	Rated	kW	1.71	2.25
	Heating <sup>1</sup>	Rated	kW	1.50	2.05
EER / COP			W/W	3.4/3.51	3.41/3.43
<b>Outdoor</b>			<b>Unit</b>	<b>ATUW18GPLT1</b>	<b>ATUW24GPLT1</b>
Power Supply			V, Ø, Hz	220 - 240, 1, 50	220 - 240, 1, 50
Power Supply Cable (included Earth)			No. x mm <sup>2</sup>	3C x 2.5	3C x 2.5
Casing Color			-	Warm Gray	Warm Gray
Dimensions	Net	W x H x D	mm	770 x 545 x 288	870 x 650 x 330
Weight	Net		kg	35.2	45.5
Compressor	Type		-	Twin Rotary	Twin Rotary
Fan Motor	Type			BLDC	BLDC
Sound Pressure Level	Cooling	Rated	dB(A)	49	50
	Heating	Rated	dB(A)	52	52
Piping Connections	Liquid	Outer Dia.	mm (inch)	Ø 6.35 (1/4)	Ø 9.52 (3/8)
	Gas	Outer Dia.	mm (inch)	Ø 12.7 (1/2)	Ø 15.88 (5/8)
Piping Length	Rated		m	5	5
	Max.		m	30	50
Maximum Height Difference (ODU - IDU)	Max.		m	15	30
<b>Indoor</b>			<b>Unit</b>	<b>ATNW18GPLT1</b>	<b>ATNW24GPLT1</b>
Panel Name				PT-UMC1 / PT-MCHWO *	PT-UMC1 / PT-MCHWO *
Power Supply			V, Ø, Hz	220-240, 1, 50	220-240, 1, 50
Dimensions	Net	W x H x D	mm	840 x 204 x 840	840 x 204 x 840
	Decoration Panel	W x H x D	mm	950 x 25 x 950	950 x 25 x 950
Weight	Net		kg	19.6	20.5
Air Flow Rate		H / M / L	m <sup>3</sup> /min	17.0 / 15.0 / 13.0	17.0 / 15.0 / 13.0
Fan Motor	Type			BLDC	BLDC
Safety Device				Fuse	Fuse
Sound Pressure Level	H / M / L		dB(A)	36 / 34 / 32	38 / 36 / 34

\* Old Panel : PT-UMC1 / New Panel : PT-MCHWO

### Notes

- Cooling<sup>1</sup> : Indoor Temperature 27°C (80.6°F) DB / 19°C (66.2°F) WB, Outdoor Temperature 35°C (95°F) DB / 24°C (75.2°F) WB
- Cooling<sup>2</sup> : Indoor Temperature 29°C (84.2°F) DB / 19°C (66.2°F) WB, Outdoor Temperature 46°C (114.8°F) DB / 24°C (75.2°F) WB
- Heating Temperature : Indoor 20°C (68°F) DB / 15°C (59°F) WB, Outdoor 7°C (44.6°F) DB / 6°C (42.8°F) WB

### HEAT PUMP

ATUW30GPLT1	ATUW36GNLT1	ATUW48GMLT1	ATUW54GMLT1
ATNW30GPLT1	ATNW36GNLT1	ATNW48GMLT1	ATNW54GMLT1
3.44-8.2-9.38	4.7-9.99-11.13	5.39-13.48-15.53	6.33-15.82-16.7
11760-28000-32000	16030-34100-38000	18400-46000-53000	21600-54000-57000
7.38	8.49	11.45	12.34
25200	28980	39100	42120
3.28-8.2-9.09	4.0-9.99-10.84	5.62-14.06-15.8	6.56-16.41-17.6
11200-28000-31000	13640-34100-37000	19200-48000-54000	22400-56000-60000
2.41	2.93	3.96	5.39
3.02	3.44	4.66	5.40
2.33	2.84	4.00	5.09
3.4/3.52	3.41/3.52	3.4/3.52	2.94/3.22
<b>ATUW30GPLT1</b>			
<b>ATUW36GNLT1</b>			
<b>ATUW48GMLT1</b>			
<b>ATUW54GMLT1</b>			
220-240, 1, 50	220-240, 1, 50	220-240, 1, 50	220-240, 1, 50
3C x 2.5	3C x 2.5	3C x 6.0	3C x 6.0
Warm Gray	Warm Gray	Warm Gray	Warm Gray
950 x 834 x 330	950 x 834 x 330	950 x 1,380 x 330	950 x 1,380 x 330
60.8	60.8	90.2	90.2
Twin Rotary	Twin Rotary	LG Inverter Scroll	LG Inverter Scroll
BLDC	BLDC	BLDC	BLDC
51	51	55	55
53	53	57	57
Ø 9.52 (3/8)	Ø 9.52 (3/8)	Ø 9.52 (3/8)	Ø 9.52 (3/8)
Ø 15.88 (5/8)	Ø 15.88 (5/8)	Ø 19.05 (3/4)	Ø 19.05 (3/4)
5	5	5	5
50	50	75	75
30	30	30	30
<b>ATNW30GPLT1</b>			
<b>ATNW36GNLT1</b>			
<b>ATNW48GMLT1</b>			
<b>ATNW54GMLT1</b>			
220-240, 1, 50	220-240, 1, 50	220-240, 1, 50	220-240, 1, 50
840 x 204 x 840	840 x 246 x 840	840 x 288 x 840	840 x 288 x 840
950 x 25 x 950	950 x 25 x 950	950 x 25 x 950	950 x 25 x 950
20.5	23.3	25.5	25.5
19.0 / 17.0 / 15.0	23.0 / 21.0 / 19.0	32.0 / 30.0 / 28.0	32.0 / 30.0 / 28.0
BLDC	BLDC	BLDC	BLDC
Fuse	Fuse	Fuse	Fuse
41 / 38 / 36	42 / 40 / 38	44 / 42 / 40	44 / 42 / 40

# SPECIFICATIONS

## CEILING MOUNTED CASSETTE - **STANDARD** (INVERTER / 1PHASE)

ATUW18GMLS1 / ATUW24GMLS1 / ATUW30GMLS1 / ATUW36GMLS1 / ATUW48GMLS1 / ATUW54GMLS1 / ATUW48LMLS2 / ATUW54LMLS2



### HEAT PUMP

Combination	Outdoor unit		Unit	ATUW18GMLS1	ATUW24GMLS1	ATUW30GMLS1
	Indoor unit			ATNW18GMLS1	ATNW24GMLS1	ATNW30GMLS1
Capacity	Cooling <sup>1</sup>	Min. - Rated - Max.	kW	1.8 - 5.2 - 5.5	2.8 - 7.0 - 8.1	3.0 - 7.8 - 8.4
		Min. - Rated - Max.	Btu/h	6,100 - 17,700 - 18,800	9,600 - 23,900 - 27,600	10,200 - 26,600 - 28,700
	Cooling <sup>2</sup>	Rated	kW	4.20	5.75	6.40
		Rated	Btu/h	14,300	19,600	21,800
	Heating	Min. - Rated - Max.	kW	1.9 - 5.3 - 5.8	3.0 - 7.6 - 8.6	3.2 - 8.4 - 8.8
		Min. - Rated - Max.	Btu/h	6,500 - 18,100 - 19,800	10,200 - 25,900 - 29,300	10,900 - 28,700 - 30,000
Power Input	Cooling <sup>1</sup>	Rated	kW	1.62	2.33	2.59
	Cooling <sup>2</sup>	Rated	kW	1.75	2.60	3.15
	Heating	Rated	kW	1.56	2.24	2.77
EER / COP	Cooling <sup>1</sup> / Heating		W / W	3.21 / 3.41	3.01 / 3.40	3.01 / 3.01
<b>Outdoor Unit</b>				<b>ATUW18GMLS1</b>	<b>ATUW24GMLS1</b>	<b>ATUW30GMLS1</b>
Power Supply			V, Ø, Hz	220-240, 1, 50	220-240, 1, 50	220-240, 1, 50
Power Supply Cable (included Earth)			No. x mm <sup>2</sup> (AWG)	3C x 2.5 (12)	3C x 2.5 (12)	3C x 2.5 (12)
Casing Color			-	Warm Gray	Warm Gray	Warm Gray
Dimensions		W x H x D	mm	770 x 545 x 288	870 x 650 x 330	870 x 650 x 330
Net Weight		Body	kg (lbs)	35.5 (78.3)	44.8 (98.8)	44.8 (98.8)
Compressor	Type		-	Twin Rotary	Twin Rotary	Twin Rotary
Refrigerant	Type		-	R410A	R410A	R410A
Fan Motor	Type		-	BLDC	BLDC	BLDC
Sound Pressure Level	Cooling	Rated	dB(A)	53	55	55
	Heating	Rated	dB(A)	54	56	56
Piping Connections	Liquid	Outer Dia.	mm (inch)	Ø 6.35 (1/4)	Ø 9.52 (3/8)	Ø 9.52 (3/8)
	Gas	Outer Dia.	mm (inch)	Ø 12.7 (1/2)	Ø 15.88 (5/8)	Ø 15.88 (5/8)
Piping Length	Max.		m (ft)	25 (82.0)	30 (98.4)	30 (98.4)
Maximum Height Difference	Outdoor Unit - Indoor Unit	Max.	m (ft)	15 (49.2)	30 (98.4)	30 (98.4)
<b>Indoor</b>				<b>ATNW18GMLS1</b>	<b>ATNW24GMLS1</b>	<b>ATNW30GMLS1</b>
Panel Name			Unit	PT-UMC1	PT-UMC1	PT-UMC1
Power Supply			V, Ø, Hz	220-240, 1, 50	220-240, 1, 50	220-240, 1, 50
Dimensions		Body	W x H x D	mm	840 x 204 x 840	840 x 204 x 840
Net Weight				kg (lbs)	21 (46.3)	21 (46.3)
Air Flow Rate		H / M / L		m <sup>3</sup> /min	16.5 / 14.5 / 13.0	17.0 / 15.0 / 13.0
Fan Motor	Type		-	BLDC	BLDC	BLDC
Sound Pressure Level	Cooling	H / M / L	dB(A)	38 / 36 / 34	40 / 38 / 36	42 / 39 / 37
	Heating	H / M / L	dB(A)	38 / 36 / 34	40 / 38 / 36	42 / 39 / 37
Safety Devices			-	Fuse	Fuse	Fuse

#### Notes

- Cooling<sup>1</sup>: Indoor Temperature 27°C (80.6°F) DB / 19°C (66.2°F) WB, Outdoor Temperature 35°C (95°F) DB / 24°C (75.2°F) WB
- Cooling<sup>2</sup>: Indoor Temperature 29°C (84.2°F) DB / 19°C (66.2°F) WB, Outdoor Temperature 46°C (114.8°F) DB / 24°C (75.2°F) WB
- Heating Temperature: Indoor 20°C (68°F) DB / 15°C (59°F) WB, Outdoor 7°C (44.6°F) DB / 6°C (42.8°F) WB

### HEAT PUMP

ATUW36GMLS1	ATUW48GMLS1	ATUW54GMLS1	ATUW48LMLS2	ATUW54LMLS2
ATNW36GMLS1	ATNW48GMLS1	ATNW54GMLS1	ATNW48LMLS2	ATNW54LMLS2
4.0 - 10.5 - 11.0	5.6 - 14.0 - 15.0	6.0 - 15.0 - 16.0	5.6 - 14.0 - 15.0	6.0 - 15.0 - 16.0
13,600 - 35,800 - 37,500	19,100 - 47,800 - 51,200	20,500 - 51,200 - 54,600	19,100 - 47,800 - 51,200	20,500 - 51,200 - 54,600
8.70	12.10	12.40	12.10	12.40
29,700	41,300	42,300	41,300	42,300
4.3 - 11.2 - 11.7	6.1 - 15.3 - 16.5	6.8 - 16.9 - 18.2	6.1 - 15.3 - 16.5	6.8 - 16.9 - 18.2
14,700 - 38,200 - 39,900	20,800 - 52,200 - 56,300	23,200 - 57,700 - 62,100	20,800 - 52,200 - 56,300	23,200 - 57,700 - 62,100
3.49	4.38	4.95	4.38	4.95
3.50	5.14	5.25	5.14	5.25
3.19	4.49	5.45	4.49	5.45
3.00 / 3.51	3.20 / 3.41	3.03 / 3.10	3.20 / 3.41	3.03 / 3.10
ATUW36GMLS1	ATUW48GMLS1	ATUW54GMLS1	ATUW48LMLS2	ATUW54LMLS2
220-240, 1, 50	220-240, 1, 50	220-240, 1, 50	380-415, 3, 50	380-415, 3, 50
3C x 2.5 (12)	3C x 6.0 (10)	3C x 6.0 (10)	5C x 2.5 (12)	5C x 2.5 (12)
Warm Gray	Warm Gray	Warm Gray	Warm Gray	Warm Gray
950 x 834 x 330	950 x 1,380 x 330	950 x 1,380 x 330	950 x 1,380 x 330	950 x 1,380 x 330
58.0 (127.9)	90.0 (198.4)	90.0 (198.4)	90.0 (198.4)	90.0 (198.4)
Twin Rotary	Twin Rotary	Twin Rotary	Twin Rotary	Twin Rotary
R410A	R410A	R410A	R410A	R410A
BLDC	BLDC	BLDC	BLDC	BLDC
56	55	55	55	55
58	57	57	57	57
Ø 9.52 (3/8)	Ø 9.52 (3/8)	Ø 9.52 (3/8)	Ø 9.52 (3/8)	Ø 9.52 (3/8)
Ø 15.88 (5/8)	Ø 19.05 (3/4)	Ø 19.05 (3/4)	Ø 19.05 (3/4)	Ø 19.05 (3/4)
40 (131.2)	50 (164.0)	50 (164.0)	50 (164.0)	50 (164.0)
30 (98.4)	30 (98.4)	30 (98.4)	30 (98.4)	30 (98.4)
ATNW36GMLS1	ATNW48GMLS1	ATNW54GMLS1	ATNW48LMLS2	ATNW54LMLS2
PT-UMC1	PT-UMC1	PT-UMC1	PT-UMC1	PT-UMC1
220-240, 1, 50	220-240, 1, 50	220-240, 1, 50	220-240, 1, 50	220-240, 1, 50
840 x 288 x 840	840 x 288 x 840	840 x 288 x 840	840 x 288 x 840	840 x 288 x 840
28 (61.7)	28 (61.7)	28 (61.7)	28 (61.7)	28 (61.7)
28.5 / 24.5 / 21.0	32.0 / 30.0 / 27.5	32.0 / 30.0 / 27.5	32.0 / 30.0 / 27.5	32.0 / 30.0 / 27.5
BLDC	BLDC	BLDC	BLDC	BLDC
48 / 46 / 44	52 / 51 / 48	52 / 51 / 48	52 / 51 / 48	52 / 51 / 48
48 / 46 / 44	52 / 51 / 48	52 / 51 / 48	52 / 51 / 48	52 / 51 / 48
Fuse	Fuse	Fuse	Fuse	Fuse



# CEILING CONCEALED DUCT



## E.S.P. (EXTERNAL STATIC PRESSURE) CONTROL

This function easily controls volume of the air by a remote controller. The BLDC motor can control fan speed and air volume regardless of the external static pressure. Additional accessories are not required to control air flow.

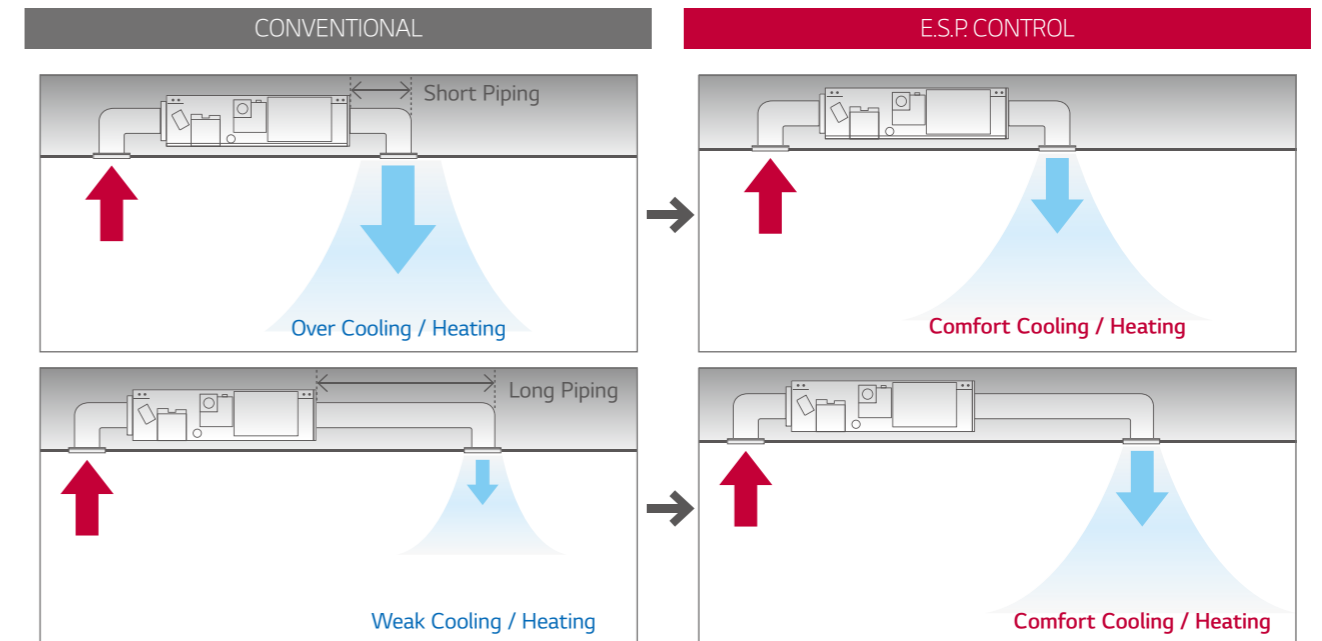

## MAXIMIZED E.S.P. (EXTERNAL STATIC PRESSURE)

With new indoor tool, connectable duct length is more longer than current running unit due to the maximum E.S.P. is improved. Noise level also decreased about 14%

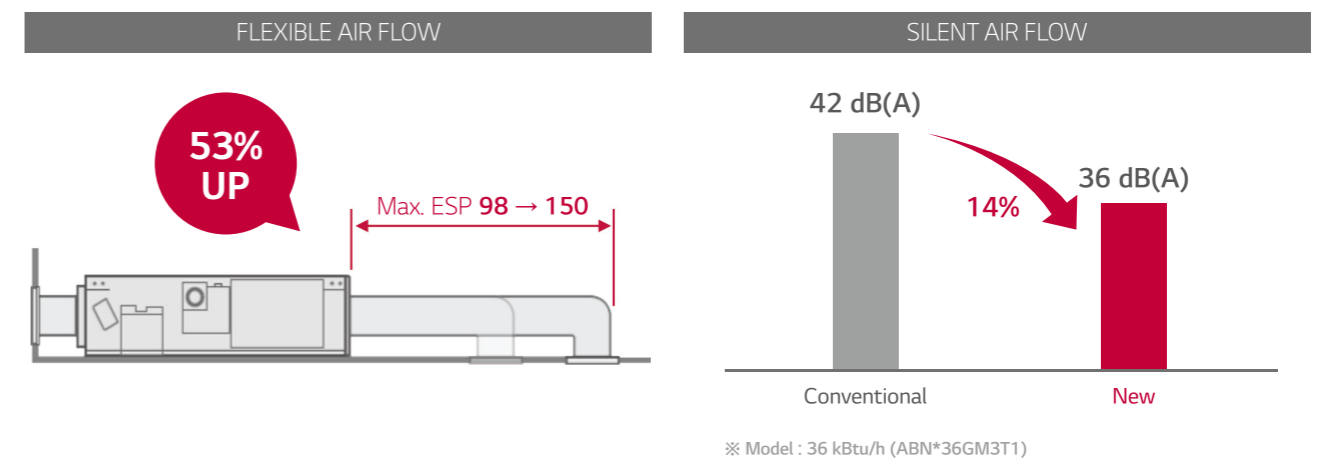

# CEILING CONCEALED DUCT

## TWO THERMISTORS CONTROL

The indoor temperature can be checked using the thermistors in the remote controller as well as from the indoor unit. There may be a significant difference between ceiling and floor air temperature. Two thermistors can optimise indoor air temperature for a more comfortable environment.

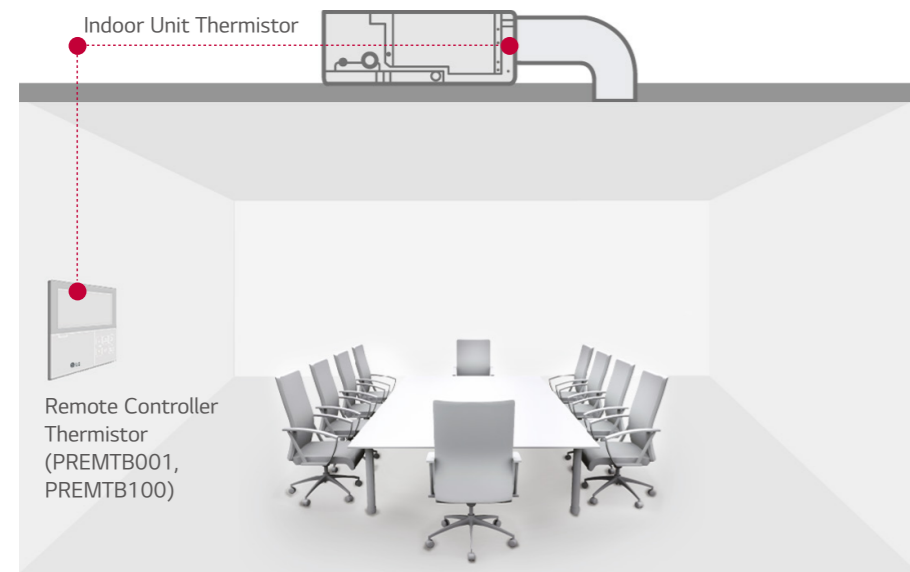

Compares temperatures sensed from different positions, and automatically selects the optimum temperature for users

## OPERATION FOR MULTIPLE ROOMS

Using a spiral duct (Embedded or flexible type) and stream chamber, it is possible to operate cooling / heating for several rooms simultaneously. Also, zone control is available with zone controller accessory (ABZCA)

### Zone control features

- Controls different zones (up to 4 zones) by external thermostat (AC 24V)
- Maintain proper air volume of each zone
- Auto variation of dampers
- Auto control of fan speed and On / Off operation

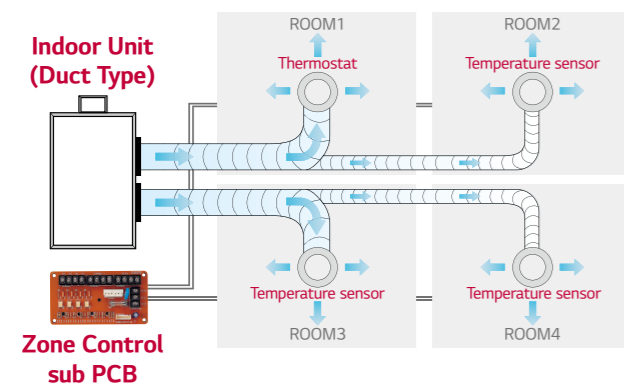

※ This function is not applicable in all countries.

## MINIMIZED HEIGHT

New mid-static ducts provide ideal solution for installation in limited space.

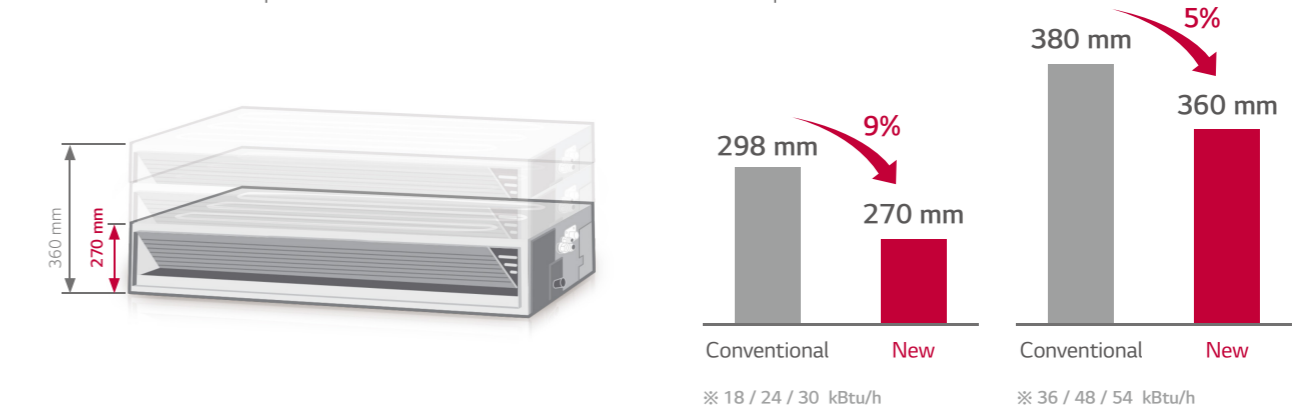

## HIGH HEAD DRAIN PUMP

High head drain pump automatically drains water up to a height of 200mm of drain-head height. It provides the perfect solution for draining of water. (Standard Inverter : Accessory (ABDPG) / Low-Static Duct : Included)

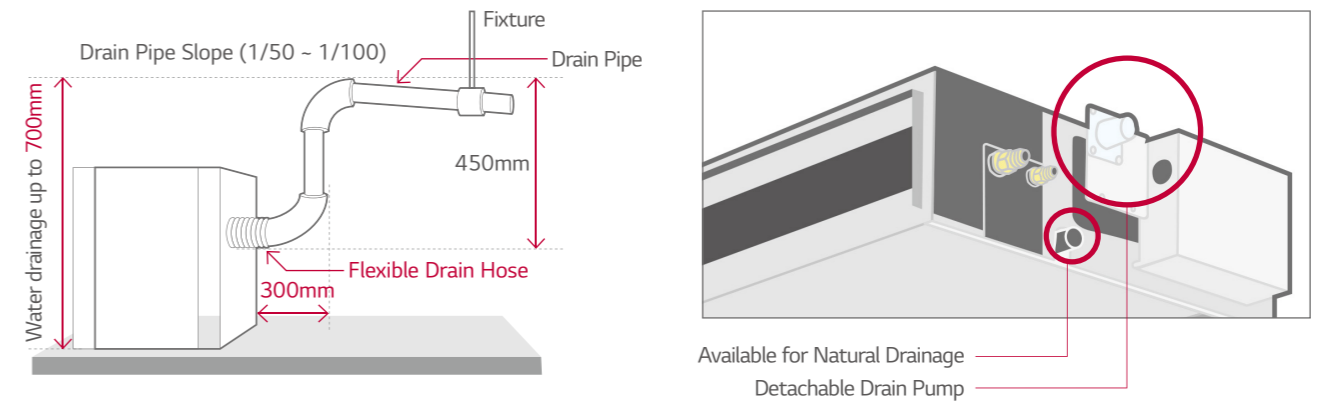

Available for Natural Drainage  
Detachable Drain Pump

## EASY SERVICE & MAINTENANCE

Users are not required to disassemble the whole panel for maintenance, since panel is divided into 2 components; one for heat exchanger and the other for fan/motor. The user can easily detach and re-attach the filter in the available limited space.

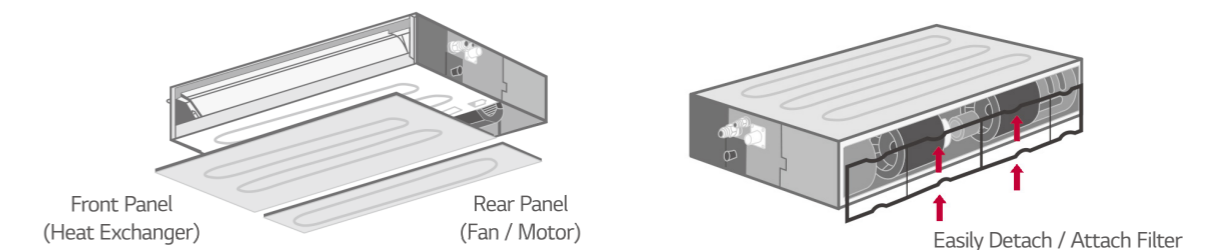



# SPECIFICATIONS

## CEILING CONCEALED DUCT - HIGH EFFICIENCY (INVERTER / 1 PHASE)

ABUQ18GM1T1 / ABUQ24GM1T1 / ABUQ30GM1T1 / ABUQ36GM3T1 / ABUQ48GM3T1 / ABUQ54GM3T1



### COOLING ONLY

Combination	Outdoor unit		Unit	ABUQ18GM1T1	ABUQ24GM1T1
	Indoor unit			ABNQ18GM1T1	ABNQ24GM1T1
Cooling Capacity <sup>1)</sup>	Min. - Rated - Max.		kW	2.1-5.27-5.86	2.81-7.03-7.91
			Btu/h	7200-18000-20000	9600-24000-27000
Cooling Capacity <sup>2)</sup>	Min. - Rated - Max.		kW	4.53	5.86
			Btu/h	15,480	20,000
Power Input	Cooling <sup>1)</sup>	Rated	kW	1.55	2.06
	Cooling <sup>2)</sup>	Rated	kW	1.72	2.32
EER / COP			W/W	3.4	3.41
<b>Outdoor</b>			<b>Unit</b>	<b>ABUQ18GM1T1</b>	<b>ABUQ24GM1T1</b>
Power Supply			V, ∅, Hz	220-240, 1, 50	220-240, 1, 50
Power Supply Cable (included Earth)			No. × mm <sup>2</sup>	3C × 2.5	3C × 2.5
Casing Color			-	Warm Gray	Warm Gray
Dimensions	Net	W × H × D	mm	770 × 545 × 288	870 × 650 × 330
Weight	Net		kg	34.3	43.3
Compressor	Type		-	Twin Rotary	Twin Rotary
Refrigerant	Type		-	R410A	R410A
Fan Motor	Type		-	BLDC	BLDC
Sound Pressure Level	Cooling	Rated	dB(A)	49	50
Piping Connections	Liquid	Outer Dia.	mm (inch)	∅ 6.35 (1/4)	∅ 9.52 (3/8)
	Gas	Outer Dia.	mm (inch)	∅ 12.7 (1/2)	∅ 15.88 (5/8)
Piping Length		Rated	m	5	5
		Max.	m	30	50
Maximum Height Difference (ODU - IDU)	Max.		m	15	30
<b>Indoor</b>			<b>Unit</b>	<b>ABNQ18GM1T1</b>	<b>ABNQ24GM1T1</b>
Type			-	Ceiling Concealed Duct-Mid. Pressure	
Power Supply			V, ∅, Hz	220-240, 1, 50	220-240, 1, 50
Dimensions	Net	W × H × D	mm	900 × 270 × 700	900 × 270 × 700
Weight	Net		kg	23.8	25.3
Air Flow Rate		H / M / L	m <sup>3</sup> /min	16.5 / 14.5 / 13.0	18.0 / 16.5 / 14.5
		Max.	m <sup>3</sup> /min	23.8	23.8
External static pressure	High Mode_Factory Set		Pa (mmAq)	6	6
Fan Motor	Type		-	BLDC	BLDC
Safety Device			-	Fuse	Fuse
Sound Pressure Level	H / M / L		dB(A)	34 / 32 / 30	37 / 35 / 32

#### Notes

- Cooling<sup>1)</sup>: Indoor Temperature 27°C (80.6°F) DB / 19°C (66.2°F) WB, Outdoor Temperature 35°C (95°F) DB / 24°C (75.2°F) WB  
 - Cooling<sup>2)</sup>: Indoor Temperature 29°C (84.2°F) DB / 19°C (66.2°F) WB, Outdoor Temperature 46°C (114.8°F) DB / 24°C (75.2°F) WB

### COOLING ONLY

ABUQ30GM1T1	ABUQ36GM3T1	ABUQ48GM3T1	ABUQ54GM3T1
ABNQ30GM1T1	ABNQ36GM3T1	ABNQ48GM3T1	ABNQ54GM3T1
3.36-8.2-9.96	4.7-9.99-11.13	5.392-13.48-15.53	6.328-15.82-16.7
11480-28000-34000	16030-34100-38000	18400-46000-53000	21600-54000-57000
7.05	8.49	11.59	12.66
24,080	28,980	39,560	43,200
2.41	2.93	3.96	5.39
2.74	3.24	4.27	5.07
3.4	3.41	3.4	2.94
<b>ABUQ30GM1T1</b>	<b>ABUQ36GM3T1</b>	<b>ABUQ48GM3T1</b>	<b>ABUQ54GM3T1</b>
220-240, 1, 50	220-240, 1, 50	220-240, 1, 50	220-240, 1, 50
3C × 2.5	3C × 2.5	3C × 6.0	3C × 6.0
Warm Gray	Warm Gray	Warm Gray	Warm Gray
950 × 834 × 330	950 × 834 × 330	950 × 1,380 × 330	950 × 1,380 × 330
59.1	59.1	89.5	89.5
Twin Rotary	Twin Rotary	LG Inverter Scroll	LG Inverter Scroll
R410A	R410A	R410A	R410A
BLDC	BLDC	BLDC	BLDC
51	51	55	55
∅ 9.52 (3/8)	∅ 9.52 (3/8)	∅ 9.52 (3/8)	∅ 9.52 (3/8)
∅ 15.88 (5/8)	∅ 15.88 (5/8)	∅ 19.05 (3/4)	∅ 19.05 (3/4)
5	5	5	5
50	50	75	75
30	30	30	30
<b>ABNQ30GM1T1</b>	<b>ABNQ36GM3T1</b>	<b>ABNQ48GM3T1</b>	<b>ABNQ54GM3T1</b>
Ceiling Concealed Duct-Mid. Pressure			
220-240, 1, 50	220-240, 1, 50	220-240, 1, 50	220-240, 1, 50
900 × 270 × 700	1,250 × 360 × 700	1,250 × 360 × 700	1,250 × 360 × 700
25.3	37.5	43.5	43.5
22.0 / 20.0 / 18.0	30.0 / 25.0 / 20.0	40.0 / 34.0 / 28.0	50.0 / 45.0 / 40.0
25.9	41.0	58.8	58.8
6	6	6	6
BLDC	BLDC	BLDC	BLDC
Fuse	Fuse	Fuse	Fuse
37 / 35 / 34	36 / 33 / 31	38 / 36 / 34	46 / 44 / 42

# SPECIFICATIONS

## CEILING CONCEALED DUCT - HIGH EFFICIENCY (INVERTER / 1 PHASE)

ABUW18GM1T1 / ABUW24GM1T1 / ABUW30GM1T1 / ABUW36GM3T1 / ABUW48GM3T1 / ABUW54GM3T1



### HEAT PUMP

Combination	Outdoor unit		Unit	ABUW18GM1T1	ABUW24GM1T1
	Indoor unit			ABNW18GM1T1	ABNW24GM1T1
Cooling Capacity <sup>1)</sup>	Min. - Rated - Max.	kW	2.1-5.27-5.86	2.81-7.03-7.91	
		Btu/h	7200-18000-20000	9600-24000-27000	
Cooling Capacity <sup>2)</sup>	Min. - Rated - Max.	kW	4.53	5.86	
		Btu/h	15480	20000	
Heating Capacity <sup>1)</sup>	Min. - Rated - Max.	kW	2.1-5.27-6.1	2.8-7.03-8.2	
		Btu/h	7200-18000-21000	9600-24000-28000	
Power Input	Cooling <sup>1)</sup>	Rated	kW	1.55	2.06
	Cooling <sup>2)</sup>	Rated	kW	1.72	2.32
	Heating <sup>1)</sup>	Rated	kW	1.50	2.05
EER / COP			W/W	3.4/3.51	3.41/3.43
<b>Outdoor</b>			<b>Unit</b>	<b>ABUW18GM1T1</b>	<b>ABUW24GM1T1</b>
Power Supply	V, Ø, Hz			220-240, 1, 50	220-240, 1, 50
Power Supply Cable (included Earth)	No. x mm <sup>2</sup>			3C x 2.5	3C x 2.5
Casing Color				Warm Gray	Warm Gray
Dimensions	Net	W x H x D	mm	770 x 545 x 288	870 x 650 x 330
Weight	Net		kg	35.2	45.5
Compressor	Type			Twin Rotary	Twin Rotary
Refrigerant	Type			R410A	R410A
Fan	Air Flow Rate	Rated	m <sup>3</sup> /min x No.	28 x 1	50 x 1
Fan Motor	Type			BLDC	BLDC
Sound Pressure Level	Cooling	Rated	dB(A)	49	50
	Heating	Rated	dB(A)	52	52
Piping Connections	Liquid	Outer Dia.	mm (inch)	Ø 6.35 (1/4)	Ø 9.52 (3/8)
	Gas	Outer Dia.	mm (inch)	Ø 12.7 (1/2)	Ø 15.88 (5/8)
Piping Length	Rated		m	5	5
	Max.		m	30	50
Maximum Height Difference (ODU - IDU)	Max.		m	15	30
<b>Indoor</b>			<b>Unit</b>	<b>ABNW18GM1T1</b>	<b>ABNW24GM1T1</b>
Type				Ceiling Concealed Duct-Mid. Pressure	
Power Supply	V, Ø, Hz			220-240, 1, 50	220-240, 1, 50
Dimensions	Net	W x H x D	mm	900 x 270 x 700	900 x 270 x 700
Weight	Net		kg	23.8	25.3
Air Flow Rate	H / M / L		m <sup>3</sup> /min	16.5 / 14.5 / 13.0	18.0 / 16.5 / 14.5
	Max		m <sup>3</sup> /min	23.8	23.8
Fan Motor	Type			6	6
External static pressure	High Mode_Factory Set		Pa (mmAq)	BLDC	BLDC
Safety Device				Fuse	Fuse
Sound Pressure Level	H / M / L		dB(A)	34 / 32 / 30	37 / 35 / 32

#### Notes

- Cooling<sup>1)</sup> : Indoor Temperature 27°C (80.6°F) DB / 19°C (66.2°F) WB, Outdoor Temperature 35°C (95°F) DB / 24°C (75.2°F) WB
- Cooling<sup>2)</sup> : Indoor Temperature 29°C (84.2°F) DB / 19°C (66.2°F) WB, Outdoor Temperature 46°C (114.8°F) DB / 24°C (75.2°F) WB
- Heating Temperature : Indoor 20°C (68°F) DB / 15°C (59°F) WB, Outdoor 7°C (44.6°F) DB / 6°C (42.8°F) WB

### HEAT PUMP

ABUW30GM1T1	ABUW36GM3T1	ABUW48GM3T1	ABUW54GM3T1
ABNW30GM1T1	ABNW36GM3T1	ABNW48GM3T1	ABNW54GM3T1
3.36-8.2-9.96	4.7-9.99-11.13	5.39-13.48-15.53	6.33-15.82-16.7
11480-28000-34000	16030-34100-38000	18400-46000-53000	21600-54000-57000
7.05	8.49	11.59	12.66
24080	28980	39560	43200
3.28-8.2-9.09	3.75-9.38-10.26	5.62-14.06-15.8	6.56-16.41-17.6
11200-28000-31000	12800-32000-35000	19200-48000-54000	22400-56000-60000
2.41	2.93	3.96	5.39
2.74	3.24	4.27	5.07
2.55	2.46	4.00	4.61
3.4/3.22	3.41/3.81	3.4/3.52	2.94/3.56
<b>ABUW30GM1T1</b>		<b>ABUW54GM3T1</b>	
220-240, 1, 50		220-240, 1, 50	
3C x 2.5		3C x 6.0	
Warm Gray		Warm Gray	
950 x 834 x 330		950 x 1,380 x 330	
60.8		90.2	
Twin Rotary		LG Inverter Scroll	
R410A		R410A	
60 x 1		60 x 2	
BLDC		BLDC	
51		55	
53		57	
Ø 9.52 (3/8)		Ø 9.52 (3/8)	
Ø 15.88 (5/8)		Ø 19.05 (3/4)	
5		5	
50		75	
30		30	
<b>ABNW30GM1T1</b>		<b>ABNW54GM3T1</b>	
220-240, 1, 50		220-240, 1, 50	
900 x 270 x 700		1,250 x 360 x 700	
25.3		43.5	
22.0 / 20.0 / 18.0		50.0 / 45.0 / 40.0	
25.9		58.8	
6		6	
BLDC		BLDC	
Fuse		Fuse	
37 / 35 / 34		46 / 44 / 42	



# SPECIFICATIONS

## CEILING CONCEALED DUCT - **STANDARD** (INVERTER / 1PHASE)

ABUW18GM1S1 / ABUW24GM1S1 / ABUW30GM1S1 / ABUW36GM2S1 / ABUW48GM3S1 /  
ABUW54GM3S1 / ABUW50LM3S1 / ABUW60LM3S1



### HEAT PUMP

Combination	Outdoor unit		Unit	ABUW18GM1S1	ABUW24GM1S1	ABUW30GM1S1
	Indoor unit			ABNW18GM1S1	ABNW24GM1S1	ABNW30GM1S1
Capacity	Cooling <sup>1)</sup>	Min. - Rated - Max	kW	1.8 - 5.2 - 5.5	2.8 - 7.0 - 8.1	3.0 - 7.8 - 8.5
		Min. - Rated - Max	Btu/h	6,100 - 17,700 - 18,800	9,600 - 23,900 - 27,600	10,200 - 26,600 - 29,000
	Cooling <sup>2)</sup>	Rated	kW	4.20	5.75	6.50
		Rated	Btu/h	14,300	19,600	22,200
	Heating	Min. - Rated - Max	kW	1.9 - 5.3 - 6.1	3.0 - 7.6 - 8.7	3.2 - 8.0 - 9.0
		Min. - Rated - Max	Btu/h	6,500 - 18,100 - 20,800	10,200 - 25,900 - 29,700	10,900 - 28,700 - 30,700
Power Input	Cooling <sup>1)</sup>	Rated	kW	1.70	2.33	2.59
	Cooling <sup>2)</sup>	Rated	kW	1.75	2.65	3.15
	Heating <sup>1)</sup>	Rated	kW	1.65	2.30	2.65
EER / COP	Cooling <sup>1)</sup> / Heating		W/W	3.06 / 3.21	3.01 / 3.30	3.01 / 3.01
<b>Outdoor</b>			<b>Unit</b>	<b>ABUW18GM1S1</b>	<b>ABUW24GM1S1</b>	<b>ABUW30GM1S1</b>
Power Supply			V, Ø, Hz	220-240, 1, 50	220-240, 1, 50	220-240, 1, 50
Power Supply Cable (included Earth)			No. x mm <sup>2</sup>	3C x 2.5 (12)	3C x 2.5 (12)	3C x 2.5 (12)
Casing Color			-	Warm Gray	Warm Gray	Warm Gray
Dimensions	Net	W x H x D	mm	770 x 545 x 288	870 x 650 x 330	870 x 650 x 330
				Net Weight	kg	35.5 (78.3)
Compressor	Type	-				
Refrigerant	Type	-				
Fan	Air Flow Rate	Rated	m <sup>3</sup> /min x No.	28 x 1	50 x 1	50 x 1
Fan Motor	Type	-				
Sound Pressure Level	Cooling	Rated	dB(A)	53	55	55
	Heating	Rated	dB(A)	54	56	56
Piping Connections	Liquid	Outer Dia.	mm (inch)	Ø 6.35 (1/4)	Ø 9.52 (3/8)	Ø 9.52 (3/8)
	Gas	Outer Dia.	mm (inch)	Ø 12.7 (1/2)	Ø 15.88 (5/8)	Ø 15.88 (5/8)
Piping Length	Max.		m	25 (82.0)	30 (98.4)	30 (98.4)
Maximum Height Difference (ODU - IDU)	Max.		m	15 (49.2)	30 (98.4)	30 (98.4)
<b>Indoor</b>			<b>Unit</b>	<b>ABNW18GM1S1</b>	<b>ABNW24GM1S1</b>	<b>ABNW30GM1S1</b>
Power Supply			V, Ø, Hz	220-240, 1, 50	220-240, 1, 50	220-240, 1, 50
Dimensions	Net	W x H x D	mm	900 x 270 x 700	900 x 270 x 700	900 x 270 x 700
				Net Weight	kg	23.8 (52.5)
Fan	Air Flow Rate	H / M / L	m <sup>3</sup> /min	16.5 / 14.5 / 13.0	18.0 / 16.5 / 14.5	22.0 / 20.0 / 18.0
Fan Motor	Type	-				
External static pressure	High Mode_Factory Set		-	58.8 (6)	58.8 (6)	58.8 (6)
Sound Pressure Level	Cooling	Rated	dB(A)	36 / 34 / 32	37 / 36 / 34	39 / 37 / 36
	Heating	Rated	dB(A)	36 / 34 / 32	37 / 36 / 34	39 / 37 / 36

#### Notes

- Cooling<sup>1)</sup> : Indoor Temperature 27°C (80.6°F) DB / 19°C (66.2°F) WB, Outdoor Temperature 35°C (95°F) DB / 24°C (75.2°F) WB  
 - Cooling<sup>2)</sup> : Indoor Temperature 29°C (84.2°F) DB / 19°C (66.2°F) WB, Outdoor Temperature 46°C (114.8°F) DB / 24°C (75.2°F) WB  
 - Heating Temperature : Indoor 20°C (68°F) DB / 15°C (59°F) WB, Outdoor 7°C (44.6°F) DB / 6°C (42.8°F) WB

### HEAT PUMP

ABUW36GM2S1	ABUW48GM3S1	ABUW54GM3S1	ABUW50LM3S1	ABUW60LM3S1
ABNW36GM2S1	ABNW48GM3S1	ABNW54GM3S1	ABNW50LM3S1	ABNW60LM3S1
3.6 - 9.5 - 10.5	5.6 - 14.1 - 15.1	6.3 - 15.6 - 16.8	5.6 - 14.1 - 15.1	6.3 - 15.8 - 16.8
12,300 - 32,400 - 35,800	19,100 - 48,100 - 51,500	21,500 - 53,200 - 57,300	19,100 - 48,100 - 51,500	21,500 - 53,900 - 57,300
7.80	12.00	13.40	12.00	13.40
26,600	40,900	45,700	40,900	45,700
4.0 - 10.5 - 11.5	6.3 - 15.8 - 16.8	6.8 - 17 - 18.2	6.3 - 15.8 - 16.8	6.8 - 17 - 18.2
13,600 - 35,800 - 39,200	21,500 - 53,900 - 57,300	23,200 - 58,000 - 62,100	21,500 - 53,900 - 57,300	23,200 - 58,000 - 62,100
3.16	4.39	5.19	4.39	5.21
3.16	4.85	5.69	4.85	5.69
3.08	4.63	4.86	4.63	4.86
3.01 / 3.41	3.21 / 3.41	3.01 / 3.50	3.21 / 3.41	3.03 / 3.50
<b>ABUW36GM2S1</b>	<b>ABUW48GM3S1</b>	<b>ABUW54GM3S1</b>	<b>ABUW50LM3S1</b>	<b>ABUW60LM3S1</b>
220-240, 1, 50	220-240, 1, 50	220-240, 1, 50	380-415, 3, 50	380-415, 3, 50
3C x 2.5 (12)	3C x 6.0 (10)	3C x 6.0 (10)	5C x 2.5 (12)	5C x 2.5 (12)
Warm Gray	Warm Gray	Warm Gray	Warm Gray	Warm Gray
950 x 834 x 330	950 x 1,380 x 330	950 x 1,380 x 330	950 x 1,380 x 330	950 x 1,380 x 330
58.0 (127.9)	90.0 (198.4)	90.0 (198.4)	90.0 (198.4)	90.0 (198.4)
Twin Rotary	Twin Rotary	Twin Rotary	Twin Rotary	Twin Rotary
R410A	R410A	R410A	R410A	R410A
58 x 1	58 x 2	58 x 2	58 x 2	58 x 2
BLDC	BLDC	BLDC	BLDC	BLDC
56	55	55	55	55
58	57	57	57	57
Ø 9.52 (3/8)	Ø 9.52 (3/8)	Ø 9.52 (3/8)	Ø 9.52 (3/8)	Ø 9.52 (3/8)
Ø 15.88 (5/8)	Ø 19.05 (3/4)	Ø 19.05 (3/4)	Ø 19.05 (3/4)	Ø 19.05 (3/4)
40 (131.2)	50 (164.0)	50 (164.0)	50 (164.0)	50 (164.0)
30 (98.4)	30 (98.4)	30 (98.4)	30 (98.4)	30 (98.4)
<b>ABNW36GM2S1</b>	<b>ABNW48GM3S1</b>	<b>ABNW54GM3S1</b>	<b>ABNW50LM3S1</b>	<b>ABNW60LM3S1</b>
220-240, 1, 50	220-240, 1, 50	220-240, 1, 50	220-240, 1, 50	220-240, 1, 50
1,250 x 270 x 700	1,250 x 360 x 700	1,250 x 360 x 700	1,250 x 360 x 700	1,250 x 360 x 700
36.0 (79.4)	42.3 (93.3)	42.3 (93.3)	42.3 (93.3)	42.3 (93.3)
32.0 / 28.0 / 24.0	40.0 / 34.0 / 28.0	50.0 / 45.0 / 40.0	40.0 / 34.0 / 28.0	50.0 / 45.0 / 40.0
BLDC	BLDC	BLDC	BLDC	BLDC
58.8 (6)	58.8 (6)	58.8 (6)	58.8 (6)	58.8 (6)
38 / 36 / 35	41 / 39 / 37	44 / 42 / 41	41 / 39 / 37	44 / 42 / 41
38 / 36 / 35	41 / 39 / 37	44 / 42 / 41	41 / 39 / 37	44 / 42 / 41



# CEILING SUSPENDED UNIT



## IF WINNING DESIGN

With its stunning V-shaped design and black vane, LG's new ceiling-suspended air conditioner exudes modern elegance appropriate for any space.



Black Vane

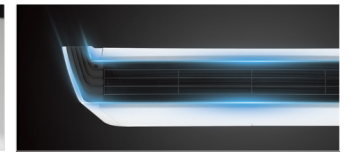

V-Shaped Design

## LARGE CAPACITY

An enlarged outlet space optimized the air flow path and improved heat exchanger's performance. It 30 percent faster cooling enable quick & wide cooling.

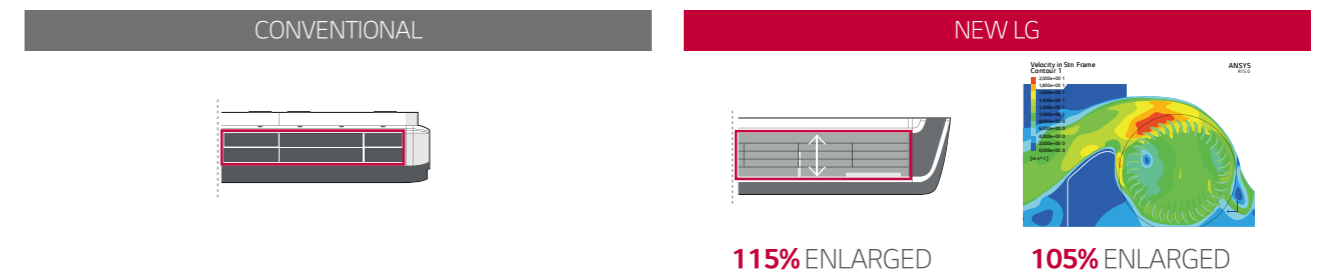

## 15M LONG AIR FLOW

The powerful air speed and high volume features enhance the flow of air to reach up to 15m away from the air conditioner.



## ONE TOUCH FILTER CHANGING

An easy In / Out filter structure as well as a simplified two-piece filter, which slides out for easy cleaning and maintenance.

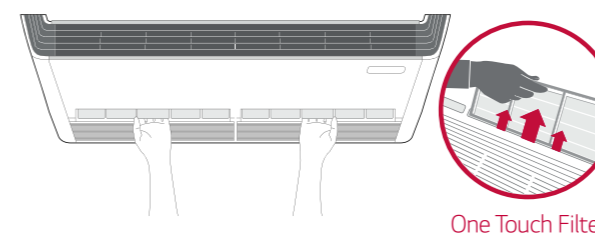

## EASY INSTALLATION

Installation speed and ease are improved by reducing the total number of screws and placing them on the easily accessible front panel.

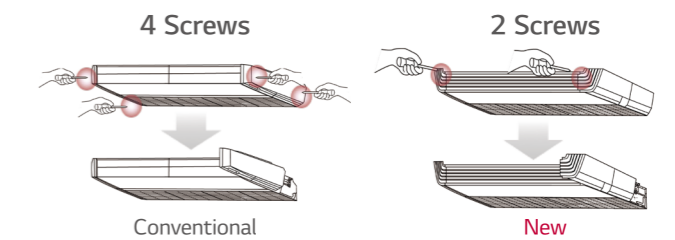



# SPECIFICATIONS

## CEILING SUSPENDED UNIT - HIGH EFFICIENCY (INVERTER / 1PHASE)

AVUQ18GM1T1 / AVUQ24GM1T1 / AVUQ30GM1T1 / AVUQ36GM2T1 / AVUQ48GM2T1 / AVUQ54GM2T1



### COOLING ONLY

Combination	Outdoor unit		Unit	AVUQ18GM1T1	AVUQ24GM1T1	
	Indoor unit			AVNQ18GM1T1	AVNQ24GM1T1	
Cooling Capacity <sup>1)</sup>	Min. - Rated - Max.		kW	2.1-5.27-5.86	2.81-7.03-7.91	
			Btu/h	7200-18000-20000	9600-24000-27000	
Cooling Capacity <sup>2)</sup>	Min. - Rated - Max.		kW	4.37	6.04	
			Btu/h	14,900	20,610	
Power Input	Cooling <sup>1)</sup>	Rated	kW	1.55	2.06	
	Cooling <sup>2)</sup>	Rated	kW	1.73	2.38	
EER / COP			W/W	3.4	3.41	
<b>Outdoor</b>			<b>Unit</b>	<b>AVUQ18GM1T1</b>	<b>AVUQ24GM1T1</b>	
Power Supply			V, Ø, Hz	220-240, 1, 50	220-240, 1, 50	
Power Supply Cable (included Earth)			No. x mm <sup>2</sup>	3C x 2.5	3C x 2.5	
Dimensions	Net	W x H x D	mm	770 x 545 x 288	870 x 650 x 330	
Weight	Net		kg	34.3	43.3	
Compressor	Type		-	Twin Rotary	Twin Rotary	
Refrigerant	Type		-	R410A	R410A	
Fan	Air Flow Rate	Rated	m <sup>3</sup> /min x No.	28 x 1	50 x 1	
		Rated	ft <sup>3</sup> /min x No.	989 x 1	1,766 x 1	
Fan Motor	Type		-	BLDC	BLDC	
Sound Pressure Level	Cooling	Rated	dB(A)	49	50	
Piping Connections	Liquid	Outer Dia.	mm (inch)	Ø 6.35 (1/4)	Ø 9.52 (3/8)	
	Gas	Outer Dia.	mm (inch)	Ø 12.7 (1/2)	Ø 15.88 (5/8)	
Piping Length		Rated	m	5	5	
		Max.	m	30	50	
Maximum Height Difference (ODU - IDU)	Max.		m	15	30	
<b>Indoor</b>			<b>Unit</b>	<b>AVNQ18GM1T1</b>	<b>AVNQ24GM1T1</b>	
Type			-	Ceiling Suspended Unit		
Power Supply			V, Ø, Hz	220-240, 1, 50	220-240, 1, 50	
Dimensions	Net	W x H x D	mm	1,200 x 235 x 690	1,200 x 235 x 690	
Weight	Net		kg	27.3	28.0	
Air Flow Rate			H / M / L	m <sup>3</sup> /min	13.0 / 12.0 / 11.0	16.5 / 15.0 / 14.0
Fan Motor	Type		-	BLDC	BLDC	
Sound Pressure Level			H / M / L	dB(A)	40 / 38 / 37	44 / 43 / 41

#### Notes

- Cooling<sup>1)</sup> : Indoor Temperature 27°C (80.6°F) DB / 19°C (66.2°F) WB, Outdoor Temperature 35°C (95°F) DB / 24°C (75.2°F) WB  
 - Cooling<sup>2)</sup> : Indoor Temperature 29°C (84.2°F) DB / 19°C (66.2°F) WB, Outdoor Temperature 46°C (114.8°F) DB / 24°C (75.2°F) WB

### COOLING ONLY

AVUQ30GM1T1	AVUQ36GM2T1	AVUQ48GM2T1	AVUQ54GM2T1
AVNQ30GM1T1	AVNQ36GM2T1	AVNQ48GM2T1	AVNQ54GM2T1
3.36-8.2-10.26	4.46-9.49-11.13	5.392-13.48-15.53	6.328-15.82-16.7
11480-28000-35000	15230-32400-38000	18400-46000-53000	21600-54000-57000
7.05	8.16	10.51	12.66
24,080	27,860	35,880	43,200
2.41	2.79	3.96	5.39
2.85	3.23	4.10	5.00
3.4	3.4	3.4	2.94
<b>AVUQ30GM1T1</b>	<b>AVUQ36GM2T1</b>	<b>AVUQ48GM2T1</b>	<b>AVUQ54GM2T1</b>
220-240, 1, 50	220-240, 1, 50	220-240, 1, 50	220-240, 1, 50
3C x 2.5	3C x 2.5	3C x 6.0	3C x 6.0
950 x 834 x 330	950 x 834 x 330	950 x 1,380 x 330	950 x 1,380 x 330
59.1	59.1	89.5	89.5
Twin Rotary	Twin Rotary	LG Inverter Scroll	LG Inverter Scroll
R410A	R410A	R410A	R410A
60 x 1	60 x 1	60 x 2	60 x 2
2,119 x 1	2,119 x 1	2,119 x 2	2,119 x 2
BLDC	BLDC	BLDC	BLDC
51	51	55	55
Ø 9.52(3/8)	Ø 9.52(3/8)	Ø 9.52 (3/8)	Ø 9.52 (3/8)
Ø 15.88 (5/8)	Ø 15.88 (5/8)	Ø 19.05 (3/4)	Ø 19.05 (3/4)
5	5	5	5
50	50	75	75
30	30	30	30
<b>AVNQ30GM1T1</b>	<b>AVNQ36GM2T1</b>	<b>AVNQ48GM2T1</b>	<b>AVNQ54GM2T1</b>
Ceiling Suspended Unit			
220-240, 1, 50	220-240, 1, 50	220-240, 1, 50	220-240, 1, 50
1,200 x 235 x 690	1,600 x 235 x 690	1,600 x 235 x 690	1,600 x 235 x 690
28.0	36.5	36.5	36.5
20.0 / 18.0 / 16.0	28.0 / 24.0 / 20.0	30.0 / 25.0 / 20.0	30.0 / 25.0 / 20.0
BLDC	BLDC	BLDC	BLDC
47 / 45 / 42	44 / 41 / 38	46 / 42 / 38	46 / 42 / 38

# SPECIFICATIONS

## CEILING SUSPENDED UNIT - HIGH EFFICIENCY (INVERTER / 1 PHASE)

AVUW18GM1T1 / AVUW24GM1T1 / AVUW30GM1T1 / AVUW36GM2T1 / AVUW48GM2T1 / AVUW54GM2T1



### HEAT PUMP

Combination	Outdoor unit		Unit	AVUW18GM1T1	AVUW24GM1T1
	Indoor unit			AVNW18GM1T1	AVNW24GM1T1
Cooling Capacity <sup>1)</sup>	Min. - Rated - Max.		kW	2.1-5.27-5.86	2.81-7.03-7.91
			Btu/h	7200-18000-20000	9600-24000-27000
Cooling Capacity <sup>2)</sup>	Min. - Rated - Max.		kW	4.37	6.04
			Btu/h	14900	20610
Heating Capacity <sup>1)</sup>	Min. - Rated - Max.		kW	2.22-5.56-6.1	2.8-7.03-8.2
			Btu/h	7600-19000-21000	9600-24000-28000
Power Input	Cooling <sup>1)</sup>	Rated	kW	1.55	2.06
	Cooling <sup>2)</sup>	Rated	kW	1.73	2.38
	Heating <sup>1)</sup>	Rated	kW	1.62	2.05
EER / COP			W/W	3.4/3.43	3.41/3.43
<b>Outdoor</b>			<b>Unit</b>	<b>AVUW18GM1T1</b>	<b>AVUW24GM1T1</b>
Power Supply			V, Ø, Hz	220-240, 1, 50	220-240, 1, 50
Power Supply Cable (included Earth)			No. x mm <sup>2</sup>	3C x 2.5	3C x 2.5
Dimensions	Net	W x H x D	mm	770 x 545 x 288	870 x 650 x 330
Weight	Net		kg	35.2	45.5
Compressor	Type		-	Twin Rotary	Twin Rotary
Refrigerant	Type		-	R410A	R410A
Fan Motor	Type		-	BLDC	BLDC
Sound Pressure Level	Cooling	Rated	dB(A)	49	50
	Heating	Rated	dB(A)	52	52
Piping Connections	Liquid	Outer Dia.	mm (inch)	Ø 6.35(1/4)	Ø 9.52(3/8)
	Gas	Outer Dia.	mm (inch)	Ø 12.7(1/2)	Ø 15.88 (5/8)
Piping Length	Rated		m	5	5
	Max.		m	30	50
Maximum Height Difference (ODU - IDU)	Max.		m	15	30
<b>Indoor</b>			<b>Unit</b>	<b>ABNW18GM1T1</b>	<b>ABNW24GM1T1</b>
Type			-	Ceiling Suspended Unit	
Power Supply			V, Ø, Hz	220-240, 1, 50	220-240, 1, 50
Dimensions	Net	W x H x D	mm	1,200 x 235 x 690	1,200 x 235 x 690
Weight	Net		kg	27.3	28.0
Air Flow Rate		H / M / L	m <sup>3</sup> /min	13.0 / 12.0 / 11.0	16.5 / 15.0 / 14.0
Fan Motor	Type		-	BLDC	BLDC
Sound Pressure Level		H / M / L	dB(A)	40 / 38 / 37	44 / 43 / 41

### HEAT PUMP

AVUW30GM1T1	AVUW36GM2T1	AVUW48GM2T1	AVUW54GM2T1
AVNW30GM1T1	AVNW36GM2T1	AVNW48GM2T1	AVNW54GM2T1
3.36-8.2-10.26	4.46-9.49-11.13	5.39-13.48-15.53	6.33-15.82-16.7
11480-28000-35000	15230-32400-38000	18400-46000-53000	21600-54000-57000
7.05	8.16	10.51	12.66
24080	27860	35880	43200
3.28-8.2-9.09	3.8-9.49-10.84	5.62-14.06-15.8	6.56-16.41-17.6
11200-28000-31000	12960-32400-37000	19200-48000-54000	22400-56000-60000
2.41	2.79	3.96	5.39
2.85	3.23	4.10	5.00
2.33	2.70	4.00	5.09
3.4/3.52	3.4/3.51	3.4/3.52	2.94/3.22
<b>AVUW30GM1T1</b>	<b>AVUW36GM2T1</b>	<b>AVUW48GM2T1</b>	<b>AVUW54GM2T1</b>
220-240, 1, 50	220-240, 1, 50	220-240, 1, 50	220-240, 1, 50
3C x 2.5	3C x 2.5	3C x 6.0	3C x 6.0
950 x 834 x 330	950 x 834 x 330	950 x 1,380 x 330	950 x 1,380 x 330
60.8	60.8	90.2	90.2
Twin Rotary	Twin Rotary	LG Inverter Scroll	LG Inverter Scroll
R410A	R410A	R410A	R410A
BLDC	BLDC	BLDC	BLDC
51	51	55	55
53	53	57	57
Ø 9.52(3/8)	Ø 9.52(3/8)	Ø 9.52 (3/8)	Ø 9.52 (3/8)
Ø 15.88 (5/8)	Ø 15.88 (5/8)	Ø 19.05 (3/4)	Ø 19.05 (3/4)
5	5	5	5
50	50	75	75
30	30	30	30
<b>AVNW30GM1T1</b>	<b>AVNW36GM2T1</b>	<b>AVNW48GM2T1</b>	<b>AVNW54GM2T1</b>
Ceiling Suspended Unit			
220-240, 1, 50	220-240, 1, 50	220-240, 1, 50	220-240, 1, 50
1,200 x 235 x 690	1,600 x 235 x 690	1,600 x 235 x 690	1,600 x 235 x 690
28.0	36.5	36.5	36.5
20.0 / 18.0 / 16.0	28.0 / 24.0 / 20.0	30.0 / 25.0 / 20.0	30.0 / 25.0 / 20.0
BLDC	BLDC	BLDC	BLDC
47 / 45 / 42	44 / 41 / 38	46 / 42 / 38	46 / 42 / 38

#### Notes

- Cooling<sup>1)</sup> : Indoor Temperature 27°C (80.6°F) DB / 19°C (66.2°F) WB, Outdoor Temperature 35°C (95°F) DB / 24°C (75.2°F) WB
- Cooling<sup>2)</sup> : Indoor Temperature 29°C (84.2°F) DB / 19°C (66.2°F) WB, Outdoor Temperature 46°C (114.8°F) DB / 24°C (75.2°F) WB
- Heating Temperature : Indoor 20°C (68°F) DB / 15°C (59°F) WB, Outdoor 7°C (44.6°F) DB / 6°C (42.8°F) WB



# FLOOR STANDING UNIT



## STYLISH DESIGN

The new LG floor standing air conditioner is ideal for modern interiors in your office or restaurant.



## EXCELLENT COOLING PERFORMANCE

Power cooling function provides the optimal airflow angle, guaranteeing a faster and higher cooling performance.

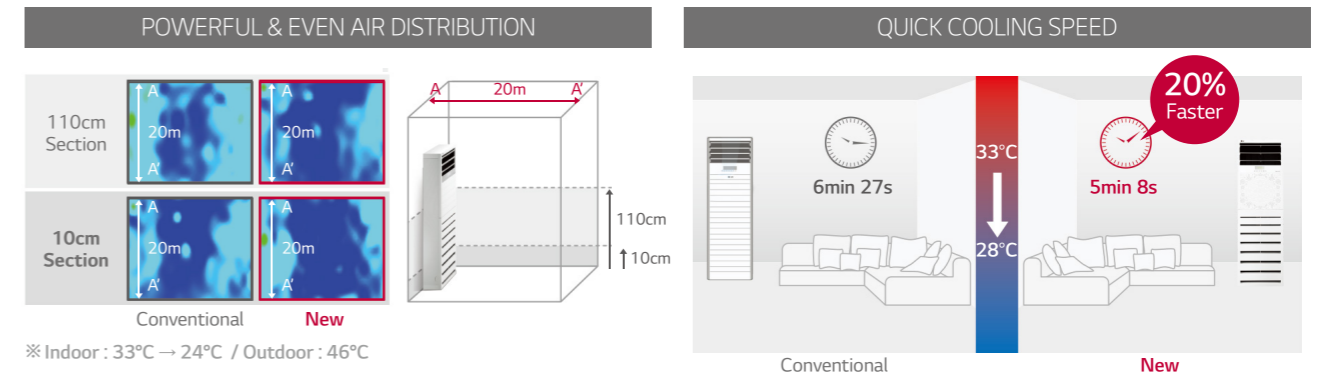

## POWERFUL AIRFLOW

The new LG floor standing air conditioner is efficient for using in large areas due to its powerful cooling and heating operation. The powerful air speed and volume means the air flow can reach up to 20m away from the air conditioner.





# SPECIFICATIONS

## FLOOR STANDING UNIT - HIGH EFFICIENCY



APUQ50LT3E0 (Cooling Only) / APUW36GT3S1 / APUW50GT3E0 / APUW50LT3E0 / APUW100LFTO



### COOLING ONLY

Combination	Outdoor unit		Unit	APUQ50LT3E0	
	Indoor unit			APNQ50LT3E0	
Capacity	Cooling <sup>1)</sup>	Min. - Rated - Max.	kW	13.51	
		Min. - Rated - Max.	Btu/h	46,100	
	Cooling <sup>2)</sup>	Rated	kW	11.72	
		Rated	Btu/h	40,000	
Power Input	Cooling <sup>1)</sup>	Min. - Rated - Max.	kW	-	
		Min. - Rated - Max.	Btu/h	-	
	Cooling <sup>2)</sup>	Rated	kW	3.88	
		Rated	kW	4.65	
EER / COP	Cooling <sup>1)</sup> / Heating	Rated	kW	-	
		Rated	kW	-	
<b>Outdoor</b>			<b>Unit</b>	<b>APUQ50LT3E0</b>	
Power Supply			V, ∅, Hz	380-415, 3, 50	
Power Supply Cable (included Earth)			No. × mm <sup>2</sup>	5C × 2.5	
Casing Color			-	Warm Gray	
Dimensions	Net	W × H × D	mm	950 × 1,380 × 330	
Net Weight		Body	kg	89.0 (196.2)	
Compressor	Type		-	Twin Rotary	
Refrigerant	Type		-	R410A	
Fan Motor	Type		-	BLDC	
Sound Pressure Level	Cooling	Rated	dB(A)	62	
	Heating	Rated	dB(A)	-	
Piping Connections	Liquid	Outer Dia.	mm (inch)	∅9.52 (3/8)	
	Gas	Outer Dia.	mm (inch)	∅19.05 (3/4)	
Piping Length		Max.	m	30 (98.4)	
Maximum Height Difference (ODU - IDU)		Max.	m	20 (65.6)	
<b>Indoor</b>			<b>Unit</b>	<b>APNQ50LT3E0</b>	
Power Supply			V, ∅, Hz	220-240, 1, 50 220, 1, 60	
Dimensions	Body	W × H × D	mm	590 × 1,840 × 440	
		W × H × D	inch	23-7/32 × 72-7/16 × 17-5/16	
Net Weight			kg (lbs)	47 (103.6)	
Fan	Air Flow Rate	SH / H / M / L	m <sup>3</sup> /min	37 / 33 / 28 / 24	
Fan Motor	Type		-	BLDC	
Sound Pressure Level	Cooling	SH / H / M / L	dB(A)	54 / 51 / 49 / 47	
	Heating	SH / H / M / L	dB(A)	-	

Notes  
 - Cooling<sup>1)</sup>: Indoor Temperature 27°C (80.6°F) DB / 19°C (66.2°F) WB, Outdoor Temperature 35°C (95°F) DB / 24°C (75.2°F) WB  
 - Heating Temperature: Indoor 20°C (68°F) DB / 15°C (59°F) WB, Outdoor 7°C (44.6°F) DB / 6°C (42.8°F) WB

### HEAT PUMP

APUW36GT3S1	APUW50GT3E0	APUW50LT3E0	APNW100LFTO
APNW36GT3S1	APNW50GT3E0	APNW50LT3E0	APUW100LFTO
38 - 100 - 106	56 - 13.51 - 15.5	56 - 13.51 - 15.5	28.43
13,000 - 34,100 - 36,200	19,100 - 46,100 - 52,900	19,100 - 46,100 - 52,900	97,000
8.10	11.72	11.72	22.57
27,600	40,000	40,000	77,000
4.1 - 10.8 - 11.5	6.2 - 14.65 - 16.7	6.2 - 14.65 - 16.7	28.72
14,000 - 36,800 - 39,200	21,200 - 50,000 - 57,000	21,200 - 50,000 - 57,000	98,000
3.32	3.88	3.88	11.20
3.27	4.65	4.65	10.80
3.17	4.15	4.15	10.50
3.01 / 3.41	3.48 / 3.53	3.48 / 3.53	2.54 / 2.74
APUW36GT3S1	APUW50GT3E0	APUW50LT3E0	APUW100LFTO
220-240, 1, 50	220-240, 1, 50	380-415, 3, 50	380-415, 3, 50
3C × 2.5 (12)	3C × 6.0	5C × 2.5	5C × 6.0
Warm Gray	Warm Gray	Warm Gray	-
950 × 834 × 330	950 × 1,380 × 330	950 × 1,380 × 330	1,090 × 1,625 × 380
58.0 (127.9)	93.5 (206.1)	93.5 (206.1)	153 (337.3)
Twin Rotary	Twin Rotary	Twin Rotary	BLDC INV Scroll
R410A	R410A	R410A	R410A
BLDC	BLDC	BLDC	BLDC
56	62	62	60
58	62	62	60
∅ 9.52 (3/8)	∅9.52 (3/8)	∅9.52 (3/8)	∅9.52 (3/8)
∅ 15.88 (5/8)	∅19.05 (3/4)	∅19.05 (3/4)	∅ 22.2 (7/8)
40 (131.2)	5 (16.4) / 30 (98.4)	5 (16.4) / 30 (98.4)	50 (164.04)
30 (98.4)	20 (65.6)	20 (65.6)	30 (98.43)
APNW36GT3S1	APNW50GT3E0	APNW50LT3E0	APNW100LFTO
220-240, 1, 50	220-240, 1, 50	220-240, 1, 50	380-415, 3, 50
220, 1, 60	220, 1, 60	220, 1, 60	1,050 × 1,880 × 495
590 × 1,840 × 440	590 × 1,840 × 440	590 × 1,840 × 440	41-1/4 × 74-7/16 × 19-1/8
23-7/32 × 72-7/16 × 18-1/8	23-7/32 × 72-7/16 × 17-5/16	23-7/32 × 72-7/16 × 17-5/16	113 (249)
47 (103.6)	47 (103.6)	47 (103.6)	68 / 61 / - / 50
37.0 / 33.0 / 30.0 / 26.0	38 / 33 / 28 / 24	38 / 33 / 28 / 24	BLDC
BLDC	BLDC	BLDC	60 / 57 / - / 53
55 / 52 / 49 / 47	55 / 52 / 49 / 47	55 / 52 / 49 / 47	-
55 / 52 / 49 / 47	55 / 52 / 49 / 47	55 / 52 / 49 / 47	380-415, 3, 50



# SPECIFICATIONS

## FLOOR STANDING UNIT - STANDARD



APUW36GT3S1 / APUW48GT3S1 / APUW48LT3S1



### HEAT PUMP

Combination	Outdoor unit		Unit	APUW36GT3S1
	Indoor unit			APNW36GT3S1
Capacity	Cooling <sup>1)</sup>	Min. - Rated - Max.	kW	3.8 - 10.0 - 10.6
		Min. - Rated - Max.	Btu/h	13,000 - 34,100 - 36,200
	Cooling <sup>2)</sup>	Rated	kW	8.10
		Rated	Btu/h	27,600
	Heating	Min. - Rated - Max.	kW	4.1 - 10.8 - 11.5
		Min. - Rated - Max.	Btu/h	14,000 - 36,800 - 39,200
Power Input	Cooling <sup>1)</sup>	Rated	kW	3.32
	Cooling <sup>2)</sup>	Rated	kW	3.27
	Heating <sup>1)</sup>	Rated	kW	3.17
EER / COP	Cooling <sup>1)</sup> / Heating		W/W	3.01 / 3.41
<b>Outdoor</b>			<b>Unit</b>	<b>APUW36GT3S1</b>
Power Supply			V, ∅, Hz	220-240, 1, 50
Power Supply Cable (included Earth)			No. × mm <sup>2</sup>	3C × 2.5 (12)
Casing Color			-	Warm Gray
Dimensions	Net	W × H × D	mm	950 × 834 × 330
	Net Weight	Body	kg	58.0 (127.9)
Compressor	Type	-	-	Twin Rotary
Refrigerant	Type	-	-	R410A
Fan Motor	Type	-	-	BLDC
Sound Pressure Level	Cooling	Rated	dB(A)	56
	Heating	Rated	dB(A)	58
Piping Connections	Liquid	Outer Dia.	mm (inch)	∅ 9.52 (3/8)
	Gas	Outer Dia.	mm (inch)	∅ 15.88 (5/8)
Piping Length	Max.		m	40 (131.2)
Maximum Height Difference (ODU - IDU)	Max.		m	30 (98.4)
<b>Indoor</b>			<b>Unit</b>	<b>APNW36GT3S1</b>
Power Supply			V, ∅, Hz	220-240, 1, 50 220, 1, 60
Dimensions	Body	W × H × D	mm	590 × 1,840 × 440
		W × H × D	inch	23-7/32 × 72-7/16 × 18-1/8
Net Weight			kg (lbs)	47 (103.6)
Fan	Air Flow Rate	SH / H / M / L	m <sup>3</sup> /min	37.0 / 33.0 / 30.0 / 26.0
Fan Motor	Type	-	-	BLDC
Sound Pressure Level	Cooling	SH / H / M / L	dB(A)	55 / 52 / 49 / 47
	Heating	SH / H / M / L	dB(A)	55 / 52 / 49 / 47

#### Notes

- Cooling<sup>1)</sup> : Indoor Temperature 27°C (80.6°F) DB / 19°C (66.2°F) WB, Outdoor Temperature 35°C (95°F) DB / 24°C (75.2°F) WB
- Cooling<sup>2)</sup> : Indoor Temperature 29°C (84.2°F) DB / 19°C (66.2°F) WB, Outdoor Temperature 46°C (114.8°F) DB / 24°C (75.2°F) WB
- Heating Temperature : Indoor 20°C (68°F) DB / 15°C (59°F) WB, Outdoor 7°C (44.6°F) DB / 6°C (42.8°F) WB

APUW48GT3S1		APUW48LT3S1
APNW48GT3S1		APNW48LT3S1
5.6 - 14.1 - 15.5		5.6 - 14.1 - 15.5
19,100 - 48,100 - 52,900		19,100 - 48,100 - 52,900
12.20		12.20
41,600		41,600
6.2 - 15.5 - 16.5		6.2 - 15.5 - 16.5
21,200 - 52,900 - 56,300		21,200 - 52,900 - 56,300
4650.00		4650.00
5100.00		5100.00
4550.00		4550.00
3.03 / 3.41		3.03 / 3.41
<b>APUW48GT3S1</b>		<b>APUW48LT3S1</b>
220-240, 1, 50		220-240, 1, 50
3C × 6.0 (10)		5C × 2.5 (12)
Warm Gray		Warm Gray
950 × 1,380 × 330		950 × 1,380 × 330
90.0 (198.4)		90.0 (198.4)
Twin Rotary		Twin Rotary
R410A		R410A
BLDC		BLDC
55		55
57		57
∅ 9.52 (3/8)		∅ 9.52 (3/8)
∅ 19.05 (3/4)		∅ 19.05 (3/4)
50 (164.0)		50 (164.0)
30 (98.4)		30 (98.4)
<b>APNW48GT3S1</b>		<b>APNW48LT3S1</b>
220-240, 1, 50		220-240, 1, 50
220, 1, 60		220, 1, 60
590 × 1,840 × 440		590 × 1,840 × 440
23-7/32 × 72-7/16 × 18-1/8		23-7/32 × 72-7/16 × 18-1/8
47 (103.6)		47 (103.6)
38.0 / 33.0 / 28.0 / 24.0		38.0 / 33.0 / 28.0 / 24.0
BLDC		BLDC
55 / 52 / 49 / 47		55 / 52 / 49 / 47
55 / 52 / 49 / 47		55 / 52 / 49 / 47





# SINGLE PACKAGE

## ANNUAL ENERGY SAVINGS

Target low pressure will be adjusted according to cooling load. LG provide energy saving by preventing On / Off operation with inverter technology.

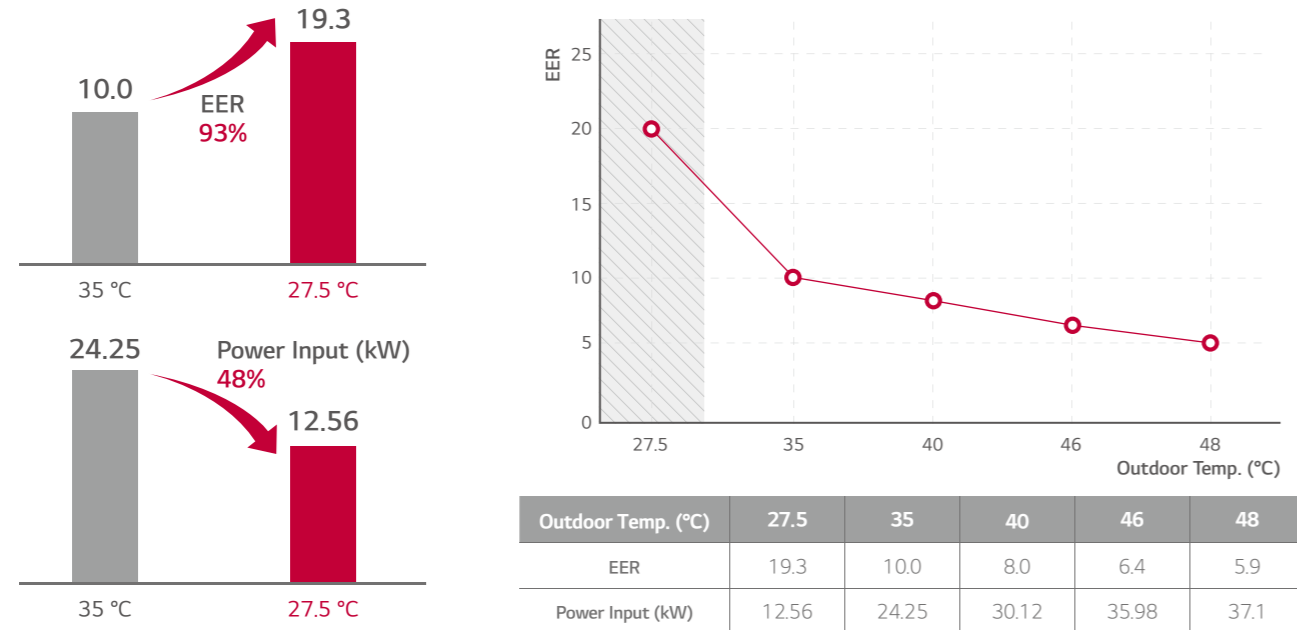

※ Model : LG AK-Q300DC01

## BENEFITS FOR CUSTOMER

Daily Energy Saving ratio compared to constant model (April 40%, Aug 20%)  
→ KSA, Madinah, real temperature based, LG DUAL Inverter elec. consumption simulation

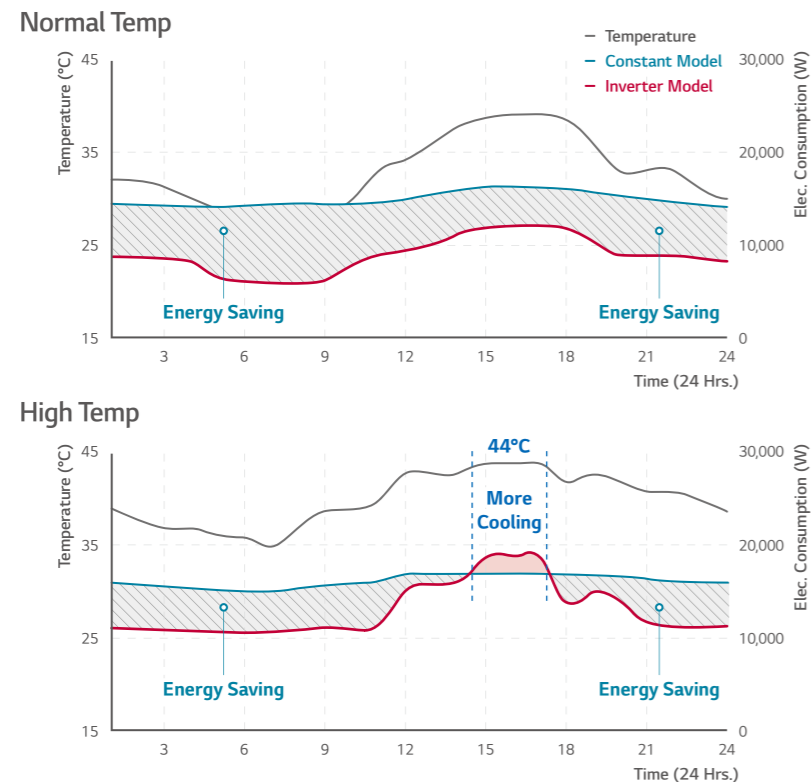

### Energy Efficiency

Time	Apr			Aug		
	Outside Temp (°C)	Elec. Consumption (W)		Outside Temp (°C)	Elec. Consumption (W)	
	Constant	Inverter	Constant	Inverter		
3:00 AM	31	1429	847	37	1563	1091
6:00 AM	28	1412	609	36	1540	1075
9:00 AM	28	1412	609	39	1607	1122
12:00 PM	34	1496	935	43	1699	1545
3:00 PM	39	1607	1181	44	1723	1896
6:00 PM	39	1607	1201	42	1674	1374
9:00 PM	33	1473	906	41	1652	1153
12:00 AM	30	1406	818	39	1607	1122

※ Data: Weather Underground, Inc.

## COMPACT SIZE

Easy transportation and less space for installation.

### REDUCED FOOTPRINT

### SIZE COMPARISON

**Footprint Comparison**

- LG Inverter: 4.37 m<sup>2</sup>
- Z Company: 6.46 m<sup>2</sup>

↑ Reduce by **32%**

**Volume Comparison**

- LG: 5.40 m<sup>3</sup> (83%)
- Z Company: 6.46 m<sup>3</sup> (100%)

**Weight Comparison**

- LG: 530 kg (37%)
- Z Company: 1,440 kg (100%)

## AUTOMATIC TEST RUN

Easy and fast automatic test run saves time during the final stage of installation.

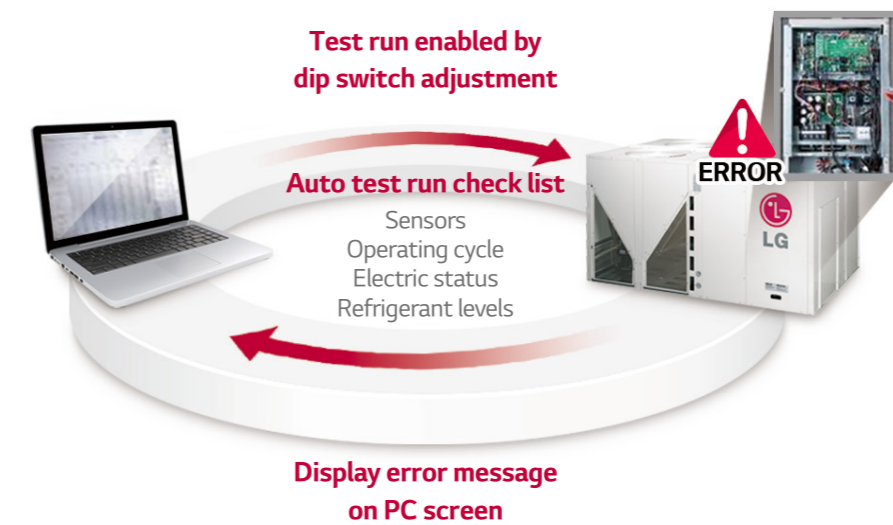

# SPECIFICATIONS

## SINGLE PACKAGE



Nominal Capacity		RT	3	4	5	
Model Name		-	AK-Q036GH50	AK-Q048GH50	AK-Q060GH50	
Cooling Capacity	Net Capacity	kW	10.26	13.63	17.35	
		kcal/h	8,820	11,718	14,918	
		Btu/h	35,000	46,500	59,200	
	Gross Capacity	kW	10.6	14.1	17.6	
		kcal/h	9,072	12,096	15,120	
		Btu/h	36,000	48,000	60,000	
EER		Btu / Wh	13.01	12.05	11.61	
Power Input	Cooling	kW	2.69	3.86	5.1	
Power Supply	V, Ø, Hz		220-240, 1, 50	220-240, 1, 50	220-240, 1, 50	
	V, Ø, Hz		220, 1, 60	220, 1, 60	220, 1, 60	
Indoor Coil	Fin Type		Wide Louver Plus			
	Tube Size	Outer Dia.	mm (inch)			
	(Row × Column × Fins per inch) × No.		-			
	Face Area		m <sup>2</sup> (ft <sup>2</sup> )			
Indoor Fan	Type		Centrifugal Blower Fan			
	Diameter		mm (inch)			
	Motor Output		W × No.			
	Air Flow Rate	Nominal	m <sup>3</sup> /min			
		Nominal	ft <sup>3</sup> /min			
	Drive type		-			
Compressor (#1, A Cycle)	Type		BLDC INV Twin Rotary			
	Motor Output		W × No.			
	Oil Type		-			
	Oil Charge		cc × No.			
	Type		-			
Compressor (#2, B Cycle)	Motor Output		W × No.			
	Oil Type		-			
	Oil Charge		cc × No.			
	Type		-			
Outdoor Coil	Fin Type		-			
	Tube Size	Outer Dia.	mm (inch)			
	(Row × Column × Fins per inch) × No.		-			
	Face Area		m <sup>2</sup> (ft <sup>2</sup> )			
Outdoor Fan	Type		Propeller			
	Diameter		mm (inch)			
	Motor Output		W × No.			
	Air Flow Rate	m <sup>3</sup> /min × No.		-		
		ft <sup>3</sup> /min × No.		-		
	Drive		BLDC Inverter			
Discharge Direction		-				
Dehumidification rate		l/h	2.23	3.47	5.58	
Drain Connection Size		-	Male NPT 3/4			
Refrigerant	Refrigerant name		R410A			
	Precharged Amount	A-Circuit	kg			
		B-Circuit	kg			
	Control		-			
Dimensions (W × H × D)	mm		1,280 × 1,065 × 1,110			
	inch		50-13 / 32 × 41-29 / 32 × 43-23 / 32			
Net Weight		kg (lbs)	174			
Sound pressure levels	Cooling	dB(A)	75			
Operation Range (Outdoor Temperature)	Cooling	Min. - Max.	°CDB (°FDB)			



Nominal Capacity		RT	6.5	7.5	
Model Name		-	AK-Q0788C01	AK-Q0908C01	
Cooling Capacity	Net Capacity	kW	22.9	26.4	
		kcal/h	19,700	22,700	
		Btu/h	78,000	90,000	
	Gross Capacity	kW	24.0	27.5	
		kcal/h	20,700	23,700	
		Btu/h	82,000	94,000	
EER		Btu / Wh	12.8	11.8	
Power Input	Cooling	kW	6.09	7.62	
Power Supply	V, Ø, Hz		380-415, 3, 50	380-415, 3, 50	
Indoor Coil	Fin Type		-		
	Tube Size	Outer Dia.	mm (inch)		
	(Row × Column × Fins per inch) × No.		-		
	Length		mm (inch)		
	Face Area		m <sup>2</sup> (ft <sup>2</sup> )		
Indoor Fan	Type		Sirocco Fan		
	Diameter		mm (inch)		
	Motor Output		Hp		
	Air Flow Rate	Nominal	m <sup>3</sup> /min		
		Nominal	ft <sup>3</sup> /min		
	Drive type		-		
Compressor (#1, A Cycle)	Type		HSS DC SCROLL		
	Motor Output		W × No.		
	Oil Type		-		
	Oil Charge		cc × No.		
	Type		-		
Compressor (#2, B Cycle)	Motor Output		W × No.		
	Oil Type		-		
	Oil Charge		cc × No.		
	Type		-		
Outdoor Coil	Fin Type		-		
	Tube Size	Outer Dia.	mm (inch)		
	(Row × Column × Fins per inch) × No.		-		
	Face Area		m <sup>2</sup> (ft <sup>2</sup> )		
Outdoor Fan	Type		Propeller Fan		
	Diameter		mm (inch)		
	Motor Output		W × No.		
	Air Flow Rate	m <sup>3</sup> /min × No.		-	
		ft <sup>3</sup> /min × No.		-	
	Drive		BLDC Inverter		
Discharge Direction		-			
Dehumidification rate		l/h	8.5		
Drain Connection Size		-	Male NPT 3/4		
Refrigerant	Refrigerant name		R410A		
	Precharged Amount	A-Circuit	kg		
		B-Circuit	kg		
	Control		-		
Dimensions (W × H × D)	mm		2,250 × 1,106 × 1,130		
	inch		88-19 / 32 × 43-17 / 32 × 44-1 / 2		
Net Weight		kg (lbs)	340 (750)		
Sound pressure levels	Cooling	dB (A)	70		
Operation Range (Outdoor Temperature)	Cooling	Min. - Max.	°CDB (°FDB)		



# SPECIFICATIONS

## SINGLE PACKAGE



Nominal Capacity		RT	10	12.5
Model Name		-	AK-Q1208C01	AK-Q1508C01
Cooling Capacity	Net Capacity	kW	35.2	39.9
		kcal/h	30,240	34,271
		Btu/h	120,000	136,000
	Gross Capacity	kW	37.5	42.8
		kcal/h	32,255	36,791
		Btu/h	128,000	146,000
EER		Btu / Wh	11.6	11.6
Power Input		Cooling	kW	10.34
Power Supply		V, Ø, Hz	380-415, 3, 50	380-415, 3, 50
Indoor Coil	Fin Type		-	LG Louver
	Tube Size	Outer Dia.	mm (inch)	9.52 (3/8)
	(Row × Column × Fins per inch) × No.		-	(4 × 22 × 16) × 2
	Length		mm (inch)	1,300 (51-6/32)
	Face Area		m <sup>2</sup> (ft <sup>2</sup> )	1.45 (15.61)
Indoor Fan	Type		-	Sirocco Fan
	Diameter		mm (inch)	380 (15)
	Motor Output		Hp	3.0
	Air Flow Rate	Nominal	m <sup>3</sup> /min	113.3
		Nominal	ft <sup>3</sup> /min	4,000
	Drive type		-	Belt
Compressor (#1, A Cycle)	Type		-	HSS DC SCROLL
	Motor Output		W × No.	5,300 × 1
	Oil Type		-	FVC68D
	Oil Charge		cc × No.	1,200 × 1
Compressor (#2, B Cycle)	Type		-	-
	Motor Output		W × No.	-
	Oil Type		-	-
	Oil Charge		cc × No.	-
Outdoor Coil	Fin Type		-	Wide Louver Plus(Gold)
	Tube Size	Outer Dia.	mm (inch)	7 (9/32)
	(Row × Column × Fins per inch) × No.		-	(3 × 42 × 14) × 2
	Face Area		m <sup>2</sup> (ft <sup>2</sup> )	3.53 (37.99)
	Outdoor Fan	Type		-
Diameter		mm (inch)	680 (26-25/32)	
Motor Output		W × No.	1,500 × 2	
Air Flow Rate		m <sup>3</sup> /min × No.	105 × 2	
		ft <sup>3</sup> /min × No.	3,700 × 2	
Drive		-	BLDC Inverter	
Discharge Direction		-	Top	
Dehumidification rate		ℓ/h	13.8	15.6
Drain Connection Size		-	Male NPT 1	Male NPT 1
Refrigerant	Refrigerant name		-	R410A
	Precharged Amount	A-Circuit	kg	13.0
		B-Circuit	kg	-
	Control		-	Electronic Expansion Valve
Dimensions (W × H × D)		mm	2,230 × 1,237 × 1,958	2,230 × 1,237 × 1,958
		inch	87-25 / 32 × 48-11 / 16 × 77-3 / 32	87-25 / 32 × 48-11 / 16 × 77-3 / 32
Net Weight		kg (lbs)	530 (1,168)	530 (1,168)
Sound pressure levels	Cooling	dB (A)	75	75
Operation Range (Outdoor Temperature)	Cooling	Min. - Max.	°CDB (°FDB)	-5 - 54 (23.0 - 129.2)



Nominal Capacity		RT	15	17.5	20	25	
Model Name		-	AK-Q1808C01	AK-Q2108C01	AK-Q2408C01	AK-Q3008C01	
Cooling Capacity	Net Capacity	kW	52.8	61.5	70.6	80.9	
		kcal/h	45,359	52,919	60,700	69,600	
		Btu/h	180,000	210,000	241,000	276,000	
	Gross Capacity	kW	54.2	64.2	73.6	85.0	
		kcal/h	46,619	55,187	63,300	73,100	
		Btu/h	185,000	219,000	251,000	290,000	
EER		Btu / Wh	11.6	12.8	11.2	10.5	
Power Input		Cooling	kW	15.50	16.40	21.50	26.20
Power Supply		V, Ø, Hz	380-415, 3, 50	380-415, 3, 50	380-415, 3, 50	380-415, 3, 50	
Indoor Coil	Fin Type		-	LG Louver	LG Louver	LG Louver	
	Tube Size	Outer Dia.	mm (inch)	9.52 (3/8)	9.52 (3/8)	9.52 (3/8)	
	(Row × Column × Fins per inch) × No.		-	(3 × 24 × 16) × 2	(3 × 24 × 16) × 2	(3 × 24 × 16) × 2	
	Length		mm (inch)	1,785 (70-9/32)	1,785 (70-9/32)	1,785 (70-9/32)	
	Face Area		m <sup>2</sup> (ft <sup>2</sup> )	2.18 (23.47)	2.18 (23.47)	2.18 (23.47)	
Indoor Fan	Type		-	Sirocco Fan	Sirocco Fan	Sirocco Fan	
	Diameter		mm (inch)	457.2 (18)	457.2 (18)	457.2 (18)	
	Motor Output		Hp	5.0	5.0	7.5	
	Air Flow Rate	Nominal	m <sup>3</sup> /min	169.9	198.2	226.5	
		Nominal	ft <sup>3</sup> /min	6,000	7,000	8,000	
	Drive type		-	Belt	Belt	Belt	
Compressor (#1, A Cycle)	Type		-	HSS DC SCROLL	HSS DC SCROLL	HSS DC SCROLL	
	Motor Output		W × No.	4,200 × 1	5,300 × 1	5,300 × 1	
	Oil Type		-	FVC68D	FVC68D	FVC68D	
	Oil Charge		cc × No.	1,200 × 1	1,400 × 1	1,400 × 1	
Compressor (#2, B Cycle)	Type		-	HSS DC SCROLL	HSS DC SCROLL	HSS DC SCROLL	
	Motor Output		W × No.	4,200 × 1	5,300 × 1	5,300 × 1	
	Oil Type		-	FVC68D	FVC68D	FVC68D	
	Oil Charge		cc × No.	1,200 × 1	1,400 × 1	1,400 × 1	
Outdoor Coil	Fin Type		-	Wide Louver Plus (Gold)	Wide Louver Plus (Gold)	Wide Louver Plus (Gold)	
	Tube Size	Outer Dia.	mm (inch)	7.0 (9/32)	7.0 (9/32)	7.0 (9/32)	
	(Row × Column × Fins per inch) × No.		-	(2 × 42 × 14) × 4	(3 × 42 × 14) × 4	(3 × 42 × 14) × 4	
	Face Area		m <sup>2</sup> (ft <sup>2</sup> )	7.06 (75.99)	7.06 (75.99)	7.06 (75.99)	
	Outdoor Fan	Type		-	Propeller Fan	Propeller Fan	Propeller Fan
Diameter		mm (inch)	680 (26-25/32)	680 (26-25/32)	680 (26-25/32)		
Motor Output		W × No.	900 × 4	900 × 4	900 × 4		
Air Flow Rate		m <sup>3</sup> /min × No.	105 × 4				
		ft <sup>3</sup> /min × No.	3,700 × 4				
Drive		-	BLDC Inverter				
Discharge Direction		-	Top				
Dehumidification rate		ℓ/h	20.7	24.2	26.18	29.82	
Drain Connection Size		-	Male NPT 1	Male NPT 1	Male NPT 1	Male NPT 1	
Refrigerant	Refrigerant name		-	R410A	R410A	R410A	
	Precharged Amount	A-Circuit	kg	9.0	12.0	12.0	
		B-Circuit	kg	9.0	12.0	12.0	
	Control		-	Electronic Expansion Valve	Electronic Expansion Valve	Electronic Expansion Valve	
Dimensions (W × H × D)		mm	2,230 × 1,242 × 3,520	2,230 × 1,242 × 3,520	2,230 × 1,242 × 3,520	2,230 × 1,242 × 3,520	
		inch	87-25 / 32 × 48-29 / 32 × 138-19 / 32	87-25 / 32 × 48-29 / 32 × 138-19 / 32	87-25 / 32 × 48-29 / 32 × 138-19 / 32	87-25 / 32 × 48-29 / 32 × 138-19 / 32	
Net Weight		kg (lbs)	850 (2,094)	900 (1,984)	950 (2,094)	950 (2,094)	
Sound pressure levels	Cooling	dB (A)	85	85	85	85	
Operation Range (Outdoor Temperature)	Cooling	Min. - Max.	°CDB (°FDB)	-5 - 54 (23.0 - 129.2)	-5 - 54 (23.0 - 129.2)	-5 - 54 (23.0 - 129.2)	

# CONTROL SOLUTION

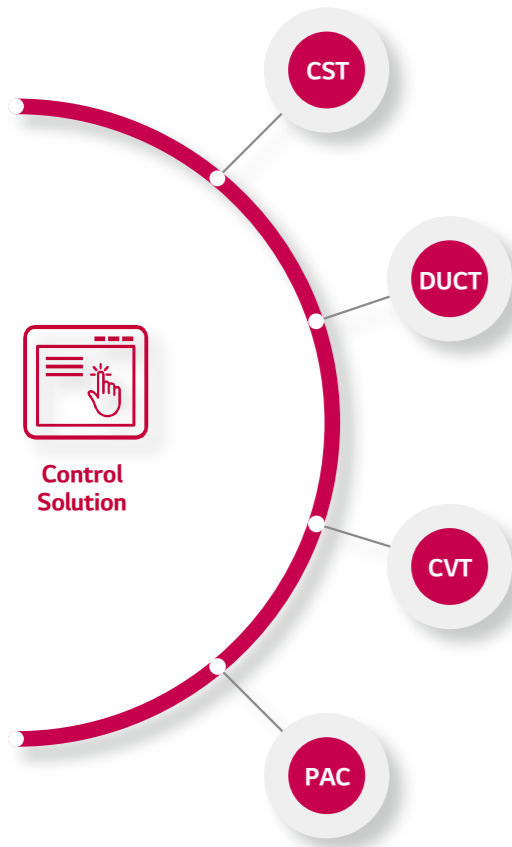

## CENTRAL CONTROL SOLUTION



- 5" Touch controller
- PI485GW required
- Individual controller Lock
- Yearly schedule
- Max 64 Indoor unit

## INDIVIDUAL CONTROLLER



- 4.3" color display with a modern design
- Soft touch button
- Yearly schedule

## DRY CONTACT SOLUTION



- 1 or 2 contact input
- With 3rd Party Thermostat
- With Automation system

## CONTROLLER LINE-UP

Smart management for a variety of usages.

### CENTRAL CONTROLLER



#### ACP 5

- Max. 256 unit
- PC, Smartphone, Tablet Control
- Yearly schedule
- BACnet / Modbus Gateway
- Individual controller Lock
- Operation log
- Floor map view



#### AC Smart 5

- Max. 128 unit
- 10.2" touch
- Yearly schedule
- BACnet / Modbus Gateway
- Individual controller Lock
- Operation log
- Floor map view



#### AC Ez touch

- Max. 64 unit
- 5" touch
- Yearly schedule
- Individual controller Lock
- Operation log

### BMS PROTOCOL GATEWAY



LonWorks

### INDIVIDUAL CONTROLLER



Standard II



Standard III  
(4.3" color)



Premium  
(5" touch color)



Wireless



LG Wi-Fi MODEM

### ETC. ACCESSORIES



Dry Contact

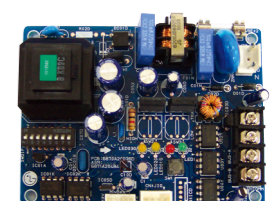

PI485GW